

# Installation Manual

## Installation & Appliance Set-Up

**INSTALLER:** Leave this manual with party responsible for use and operation.  
**OWNER:** Retain this manual for future reference.

**NOTICE: DO NOT DISCARD THIS MANUAL**

# QUADRA-FIRE®

## CB1200 PELLET INSERT APPLIANCE

**MODEL:  
CB1200I-C**

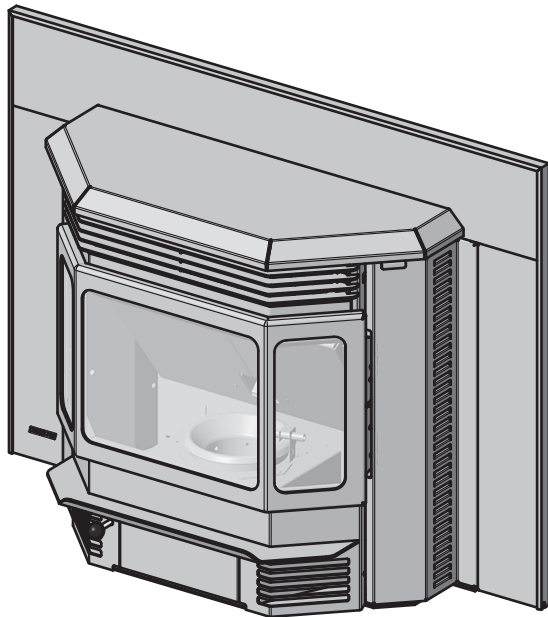

### CAUTION

Tested and approved for wood pellets and corn pellets.  
Burning of any other type of fuel voids your warranty.

Installation and service of this appliance should be performed by qualified personnel. Hearth & Home Technologies recommends HHT Factory Trained or NFI certified professionals.



### WARNING



If the information in these instructions is not followed exactly, a fire could result causing property damage, personal injury, or death.

- Do not store or use gasoline or other flammable vapors and liquids in the vicinity of this or any other appliance.
- Do not over fire - If appliance or chimney connector glows, you are over firing. Over firing will void your warranty.
- Comply with all minimum clearances to combustibles as specified. Failure to comply may cause house fire.



### WARNING



#### HOT SURFACES!

Glass and other surfaces are hot during operation AND cool down.

#### Hot glass will cause burns.

- Do not touch glass until it is cooled
- NEVER allow children to touch glass
- Keep children away
- CAREFULLY SUPERVISE children in same room as fireplace.
- Alert children and adults to hazards of high temperatures
- High temperatures may ignite clothing or other flammable materials.
- Keep clothing, furniture, draperies and other flammable materials away.



### CAUTION

Check building codes prior to installation.

- Installation MUST comply with local, regional, state and national codes and regulations.
- Consult local building, fire officials or authorities having jurisdiction about restrictions, installation inspection, and permits.

**NOTE:** To obtain a French translation of this manual, please contact your dealer or visit [www.quadrafire.com](http://www.quadrafire.com)

**REMARQUE :** Pour obtenir une traduction française de ce manuel, s'il vous plaît contacter votre revendeur ou visitez [www.quadrafire.com](http://www.quadrafire.com)

**Safety Alert Key:**



- **DANGER!** Indicates a hazardous situation which, if not avoided will result in death or serious injury.
- **WARNING!** Indicates a hazardous situation which, if not avoided could result in death or serious injury.
- **CAUTION!** Indicates a hazardous situation which, if not avoided, could result in minor or moderate injury.
- **NOTICE:** Indicates practices which may cause damage to the appliance or to property.

**TABLE OF CONTENTS**

<b>1 Important Safety Information..... 3</b>	<b>4 Vent Information..... 14</b>
A. Appliance Certification . . . . .3	A. Venting Termination Minimum Requirements . . . . .14
B. BTU & Efficiency Specifications . . . . .3	B. Avoiding Smoke and Odors . . . . .15
C. Glass Specifications . . . . .4	C. Negative Pressure. . . . .16
D. Electrical Rating . . . . .4	D. Draft . . . . .16
E. Mobile Home Approved . . . . .4	E. Chimney and Exhaust Connection . . . . .16
F. Non-Combustible Materials . . . . .4	F. Equivalent Feet of Pipe . . . . .17
G. Combustible Materials . . . . .4	G. Pipe Selection Chart . . . . .17
H. Sleeping Room . . . . .4	<b>5 Venting Systems ..... 18</b>
I. California - Prop65 . . . . .4	A. Full Reline With Outside Air - Horizontal . . . . .18
<b>2 Getting Started ..... 5</b>	B. Full Reline With Outside Air - Vertical . . . . .19
A. Design, Installation & Location Considerations . . . . .5	<b>6 Appliance Set-Up ..... 20</b>
B. Thermostat Wall Control Location . . . . .6	A. Rear Shroud Installation . . . . .20
C. Tools And Supplies Needed . . . . .6	B. Outside Air Kit Instructions . . . . .22
D. Inspect Appliance and Components . . . . .6	C. Adjustable Hopper Options . . . . .23
E. Install Checklist . . . . .7	D. Grill Installation . . . . .23
<b>3 Dimensions and Clearances ..... 8</b>	E. Optional Log Set Placement Instructions . . . . .23
A. Appliance Dimensions . . . . .8	F. Adjustable Hearth Support . . . . .24
B. Clearance To Combustibles, UL and ULC . . . . .9	G. Panel and Trim Set . . . . .25
C. Masonry Chimney and Fireplace Clearances . . . . .10	H. Thermostat Installation and Operation . . . . .26
D. Minimum Opening for Masonry & ZC Fireplaces . . . . .10	<b>7 Mobile Home Installation..... 27</b>
E. Hearth Extension. . . . .10	<b>8 Reference Materials ..... 28</b>
F. Floor Protection . . . . .11	A. Service & Maintenance List . . . . .28
G. Installation into a Factory-Built Fireplace . . . . .12	B. Accessory List . . . . .30
H. Installation into a Masonry Fireplace. . . . .13	
I. Prefabricated Metal Chimney . . . . .13	

# 1 Important Safety Information

## A. Appliance Certification

<b>Model</b>	CB1200 Pellet Insert
<b>Laboratory</b>	OMNI Test Laboratories, Inc.
<b>Safety Report No.</b>	061-S-13-2
<b>Type</b>	Solid Fuel Room Appliance/Pellet Fuel Burning Type Insert
<b>Standard</b>	ASTM E1509-95, UL127, ULC S628-93, ULC S610-M87, and ULC/ORD-C1482-M1990 Room Appliance Pellet Fuel Burning Type, (UM) 84-HUD. For use only with palletized wood or shelled field corn fuel. Mobile Home Approved

## B. BTU & Efficiency Specifications

<b>Emissions Report #:</b>	0061PN013E
<b>EPA Certification #:</b>	171-19
<b>EPA Certified Emissions:</b>	0.8 grams per hour
<b>*LHV Tested Efficiency:</b>	67.6%
<b>**HHV Tested Efficiency:</b>	63.6%
<b>***EPA BTU Output:</b>	10,200 to 33,900 / hr.
<b>****BTU Input:</b>	17,000 to 48,500 / hr.
<b>Vent Size:</b>	3, 4 "L" or "PL", or 6"
<b>Hopper Capacity:</b>	75 lbs.
<b>Fuel</b>	Premium Wood Pellets
*Weighted average LHV (Low Heating Value) efficiency using data collected during EPA emissions tests.	
**Weighted average HHV (High Heating Value) efficiency using data collected during EPA emissions tests.	
***A range of BTU outputs calculated using HHV efficiency and the burn rates from the EPA tests.	
****Based on the maximum feed rate per hour multiplied by approximately 8600 BTU's which is the average BTU's from a pound of pellets.	
‡ Grade of pellet fuel as certified by Pellet Fuels Institute (PFI), ENPlus or CANplus.	

The Classic Bay 1200 insert is Certified to comply with 2020 particulate emission standards.



This pellet insert needs periodic inspection and repair for proper operation. It is against federal regulations to operate this pellet insert in a manner inconsistent with operating instructions in this manual.

**NOTE:** This installation must conform with local codes. In the absence of local codes you must comply with the **ASTM E1509-95, UL127, ULC S628-93, ULC S610-M87, ULC/ORD-C-1482-M1990, (UM) 84-HUD**

### C. Glass Specifications

This appliance is equipped with 5mm ceramic glass. Replace glass only with 5mm ceramic glass. Please contact your dealer for replacement glass.

### D. Electrical Rating

115 VAC, 60 Hz, Start 4.1 Amps, Run 1.1 Amps

### E. Mobile Home Approved

- This appliance is approved for mobile home installations when not installed in a sleeping room and when an outside combustion air inlet is provided.
- The structural integrity of the mobile home floor, ceiling, and walls must be maintained.
- The appliance must be properly grounded to the frame of the mobile home and use only Listed pellet vent Class "L" or "PL" connector pipe.
- Outside Air Kit, part OAK-ACC must be installed in a mobile home installation.

### F. Non-Combustible Materials

Material which will not ignite and burn, composed of any combination of the following:

- Steel
- Brick
- Concrete
- Glass
- Plaster
- Iron
- Tile
- Slate

**Materials reported as passing ASTM E 136, Standard Test Method for Behavior of Metals, in a Vertical Tube Furnace of 750°C.**

### G. Combustible Materials

Material made of/or surfaced with any of the following materials:

- Wood
- Plastic
- Compressed Paper
- Plywood/OSB
- Plant Fibers
- Sheet Rock (drywall)

Any material that can ignite and burn: flame proofed or not, plastered or non-plastered.

### H. Sleeping Room

When installed in a sleeping room it is recommended that 3ft of vertical be installed prior to horizontally exiting the room and a smoke/CO alarm be installed in the bedroom. The size of the room must be at least 50ft³ per 1,000 Btu/hr stove input, if the stove exceeds the room size, out air must be installed.

### I. California - Prop65

	<b>WARNING</b>
<p>This product and the fuels used to operate this product (wood), and the products of combustion of such fuels, can expose you to chemicals including carbon black, which is known to the State of California to cause cancer, and carbon monoxide, which is known to the State of California to cause birth defects or other reproductive harm. For more information go to: <a href="http://WWW.P65Warnings.ca.gov">WWW.P65Warnings.ca.gov</a></p>	

	<b>WARNING</b>
	<p><b>Fire Risk.</b> Hearth &amp; Home Technologies disclaims any responsibility for, and the warranty will be voided by, the following actions:</p> <ul style="list-style-type: none"><li>• Installation and use of any damaged appliance.</li><li>• Modification of the appliance.</li><li>• Installation other than as instructed by Hearth &amp; Home Technologies.</li><li>• Installation and/or use of any component part not approved by Hearth &amp; Home Technologies.</li><li>• Operating appliance without fully assembling all components.</li><li>• Operating appliance without legs attached (if supplied with appliance).</li><li>• <u>Do NOT Over fire</u> - If appliance or chimney connector glows, you are over firing.</li></ul> <p>Any such action that may cause a fire hazard.</p>

Improper installation, adjustment, alteration, service or maintenance can cause injury or property damage.

For assistance or additional information, consult a qualified installer, service agency or your dealer.

<p><b>NOTE:</b> Hearth &amp; Home Technologies, manufacturer of this appliance, reserves the right to alter its products, their specifications and/or price without notice.</p>
---



# Install Guide

## 2 Getting Started

### A. Design, Installation & Location Considerations

#### 1. Appliance Location

**NOTICE:** Check building codes prior to installation.

- Installation **MUST** comply with local, regional, state and national codes and regulations.
- Consult insurance carrier, local building inspector, fire officials or authorities having jurisdiction over restrictions, installation inspection and permits.

It is a good idea to plan your installation on paper, using exact measurements for clearances and floor protection, before actually beginning the installation. Location of the appliance and chimney will affect performance.

Consideration must be given to:

- Safety, convenience, traffic flow
- Placement of the chimney and chimney connector and to minimize the use of chimney offsets.
- Place the appliance where there will be a clear passage for a Listed chimney through the ceiling and roof (vertical) or through exterior wall (horizontal).
- Installing the required outside air kit will affect the location of the vent termination.

When locating vent and venting termination, the ideal location is to vent above roof line when possible. This minimizes the affects of wind loading.

Since pellet exhaust can contain ash, soot or sparks, you must consider the location of:

- Windows
- Air Intakes
- Air Conditioner
- Overhang, soffits, porch roofs, adjacent walls
- Landscaping, vegetation
- Horizontal or vertical vent termination

#### 2. Floor Support

The supporting floor under the appliance must be able to handle the weight of the appliance, fuel load and the weight of the chimney.

Ensure that your floor will support these weights prior to installation. Add sufficient additional support to meet this weight requirement prior to installation. The weight of the appliance is 193 lbs.



### WARNING

#### Risk of Fire.

Damaged parts could impair safe operation. Do NOT install damaged, incomplete or substitute components.



### CAUTION

If burning shelled field corn, you must use approved venting specifically designed for corn to prevent corrosion or degradation. Follow the instructions from the venting manufacturer.

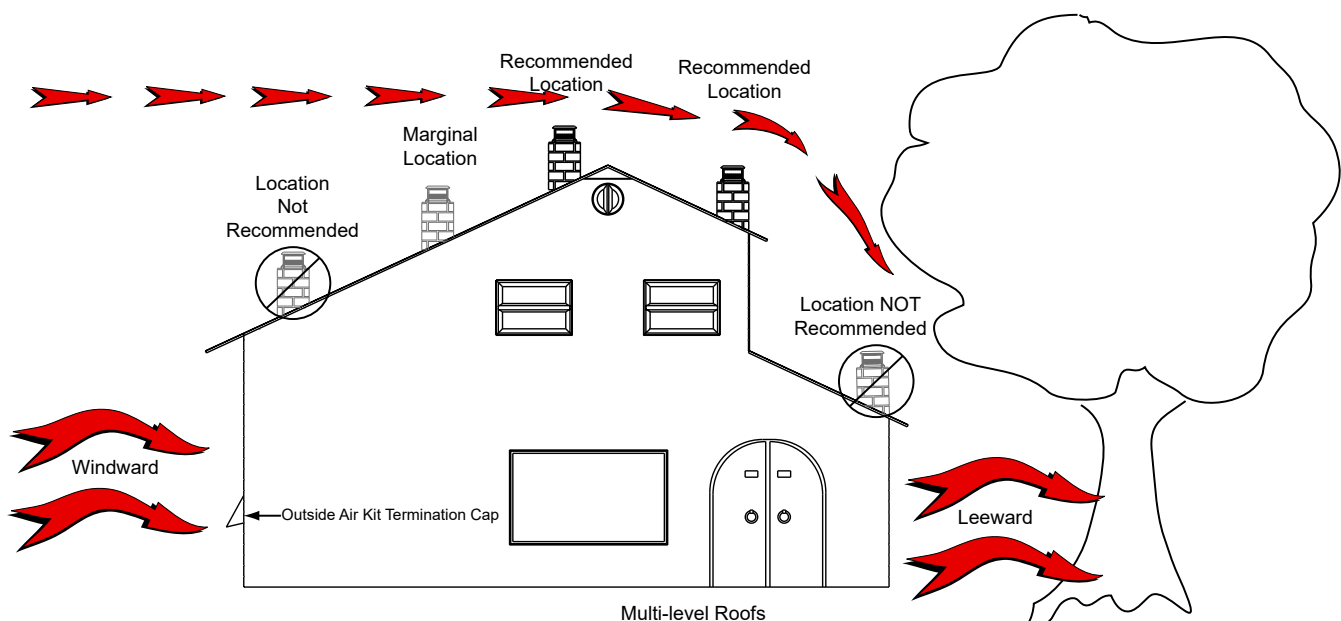



Figure 5.1

	<b>WARNING</b>
	<p><b>Risk of Fire!</b></p> <ul style="list-style-type: none"> <li>• Damaged parts could impair safe operation.</li> <li>• Do NOT install damaged, incomplete or substitute components.</li> </ul>

	<b>WARNING</b>
	<p>Hearth &amp; Home Technologies disclaims any responsibility for, and the warranty will be voided by, the following actions:</p> <ul style="list-style-type: none"> <li>• Installation and use of any damaged appliance.</li> <li>• Modification of the appliance.</li> <li>• Installation other than as instructed by Hearth &amp; Home Technologies.</li> <li>• Installation and/or use of any component part not approved by Hearth &amp; Home Technologies.</li> <li>• Operating appliance without fully assembling all components.</li> <li>• Operating appliance without legs attached (if supplied with appliance).</li> <li>• <u>Do NOT Over fire</u></li> </ul> <p><b>Or any such action that may cause a fire hazard.</b></p>

**B. Thermostat Wall Control Location**

The thermostat wall control's location will have some affect on the appliance's operation.

- Maximum wire length from appliance is 100 feet (30.48m) with continuous non-spliced wire. Recommended 20 gauge wire, solid copper.
- When located close to the appliance, it may require a slightly higher temperature setting to keep the rest of the house comfortable.
- When located in an adjacent room or on a different floor level, you will notice higher temperatures near the appliance.

**C. Tools And Supplies Needed**

Tools and building supplies normally required for installation, unless installing into an existing masonry fireplace:

- Reciprocating Saw
- Channel Locks
- Hammer
- Phillips Screwdriver
- Tape Measure
- Plumb Line
- 1/4" Self-Tapping Screws
- Framing Material
- Hi-temp Caulking Material
- Gloves
- Safety Glasses
- Framing Square
- Electric Drill & Bits (1/4")
- Level

**May also need:**

- Vent Support Straps
- Venting Paint

**D. Inspect Appliance and Components**

- Open the appliance and remove all the parts and articles packed inside the Component Pack. Inspect all the parts and glass for shipping damage.
- Report to your dealer any parts damaged in shipment.
- All labels have been removed from the glass door.
- Plated surfaces have been wiped clean with a soft cloth, if applicable.
- Read all the instructions before starting the installation. Follow these instructions carefully during the installation to ensure maximum safety and benefit.
- Follow pipe manufacturer instructions for installation and air clearance requirements.

**E. Install Checklist**

**ATTENTION INSTALLER:  
Follow this Standard Work Checklist**

This standard work checklist is to be used by the installer in conjunction with, not instead of, the instructions contained in this installation manual.

Customer: \_\_\_\_\_  
 Date Installed: \_\_\_\_\_  
 Lot/Address: \_\_\_\_\_  
 Location of Appliance: \_\_\_\_\_  
 Installer: \_\_\_\_\_  
 Dealer/Distributor Phone Number: \_\_\_\_\_  
 Serial Number: \_\_\_\_\_  
 Model Name: \_\_\_\_\_



**WARNING! Risk of Fire or Explosion! Failure to install appliance to these instructions can lead to a fire or explosion.**

**Appliance Install**

Verified clearance to combustibles.  
 Appliance is leveled and connector is secured to appliance.  
 Hearth extension size/height decided.  
 Outside air kit installed.  
 Floor protection requirements have been met.  
 If appliance is connected to a masonry chimney, it should be cleaned and inspected by a professional. If installed to a factory built metal chimney, the chimney must be installed according to the manufacturer's instructions and clearances.

**YES**

**IF NO, WHY?**

\_\_\_\_\_  
 \_\_\_\_\_  
 \_\_\_\_\_  
 \_\_\_\_\_  
 \_\_\_\_\_

**Venting/Chimney**

Chimney configuration complies with diagrams.  
 Chimney installed, locked and secured in place with proper clearance.  
 Chimney meets recommended height requirements (5 feet minimum vertical).  
 Roof flashing installed and sealed.  
 Terminations installed and sealed.

\_\_\_\_\_  
 \_\_\_\_\_  
 \_\_\_\_\_  
 \_\_\_\_\_  
 \_\_\_\_\_

**Electrical**

120 VAC unswitched power provided to the appliance.  
 Check outlet with multi-meter for proper polarity and voltage (115-120 VAC).  
 Record voltage reading: \_\_\_\_\_

\_\_\_\_\_  
 \_\_\_\_\_

**Clearances**

Verified all clearances meet installation manual requirements.  
 Mantels and wall projections comply with installation manual requirements.  
 Floor protection and heart extensions installed per manual requirements.

\_\_\_\_\_  
 \_\_\_\_\_  
 \_\_\_\_\_

**Appliance Setup**

All protective materials removed.  
 All labels have been removed from the door.  
 All packaging materials are removed from inside/under appliance.  
 Manual bag and all of its contents are removed from inside/under the appliance and given to the party responsible for use and operation.  
 Started appliance and verified that all motors and blowers operate as they should.  
 Checked draft using a Manometer. Record readings: \_\_\_\_\_  
 Checked vacuum using a Manometer. Record readings: \_\_\_\_\_

\_\_\_\_\_  
 \_\_\_\_\_  
 \_\_\_\_\_  
 \_\_\_\_\_  
 \_\_\_\_\_  
 \_\_\_\_\_

**Hearth & Home Technologies recommends the following:**

Photographing the installation and copying this checklist for your file.  
 That this checklist remain visible at all times on the appliance until the installation is complete.

**Comments:** Further description of the issues, who is responsible (Installer/Builder/Other Trades, etc.) and corrective action needed:  
 Comments communicated to party responsible \_\_\_\_\_ by \_\_\_\_\_ on \_\_\_\_\_  
 (Builder/Gen. Contractor) (Installer) (Date)

# 3 Dimensions and Clearances

## A. Appliance Dimensions

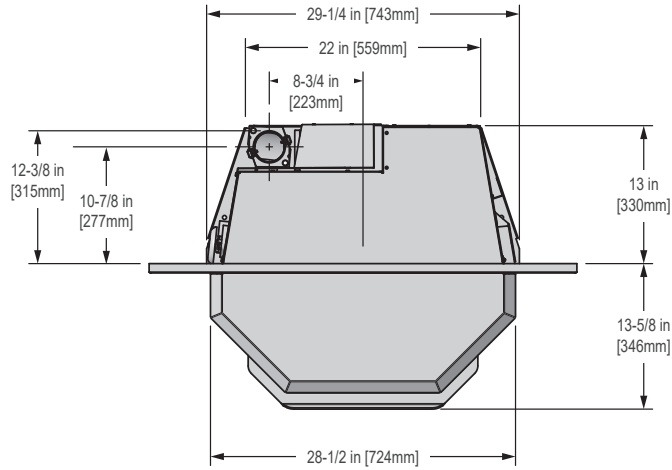

Figure 8.1 - Top View with small panel set (SP-CB12I3040-NB or NL)

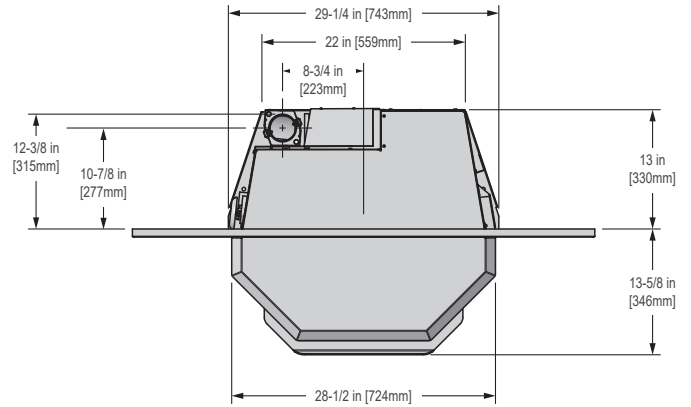

Figure 8.4 - Top View with large panel set (SP-CB12I3350-NB or NL)

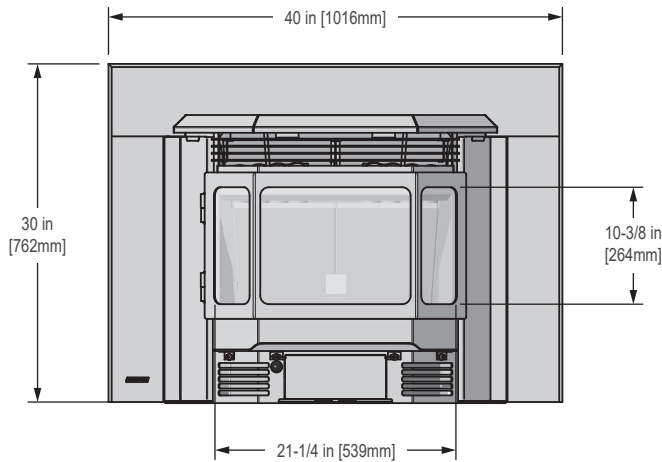

Figure 8.2 - Front View with small panel set (SP-CB12I3040-NB or NL)

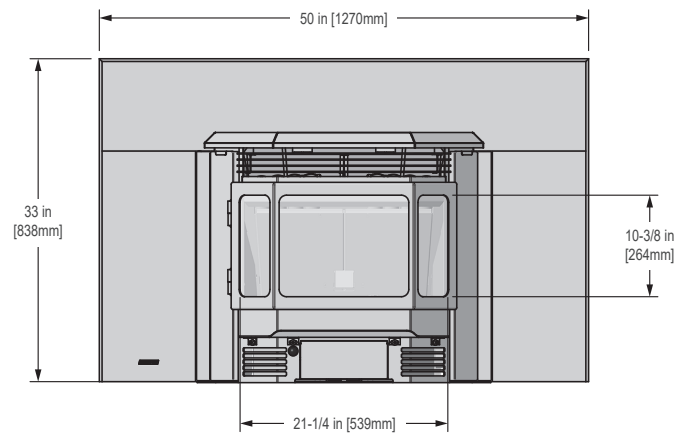

Figure 8.5 - Front View with large panel set (SP-CB12I3350-NB or NL)

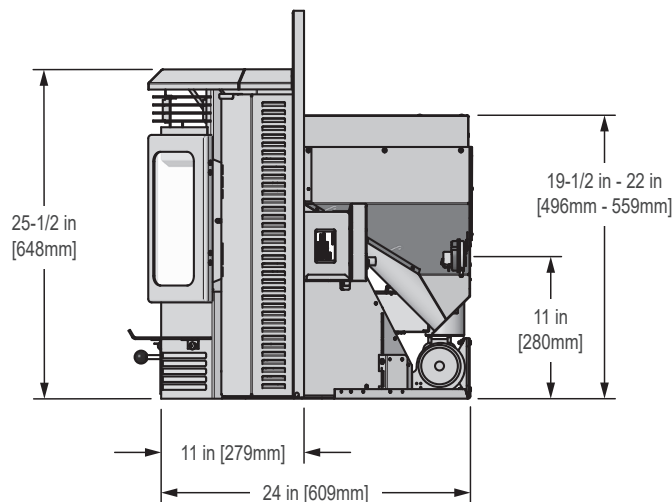

Figure 8.2 - Side View with small panel set (SP-CB12I3040-NB or NL)

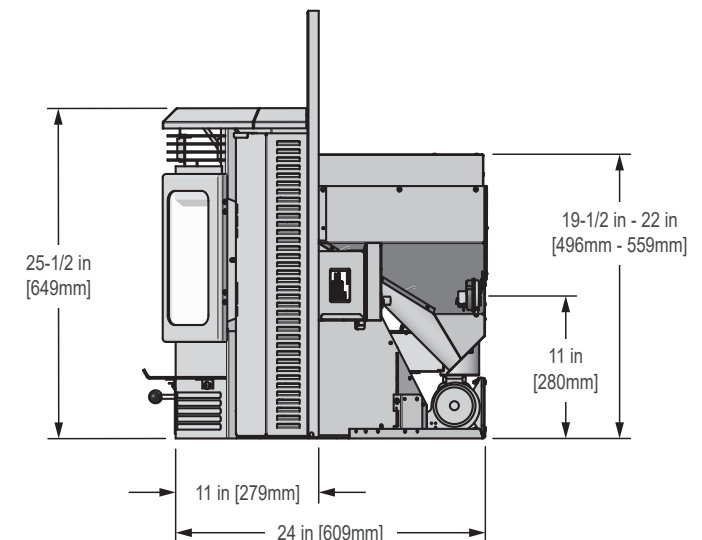

Figure 8.5 - Side View with large panel set (SP-CB12I3350-NB or NL)

**B. Clearance To Combustibles, UL and ULC**

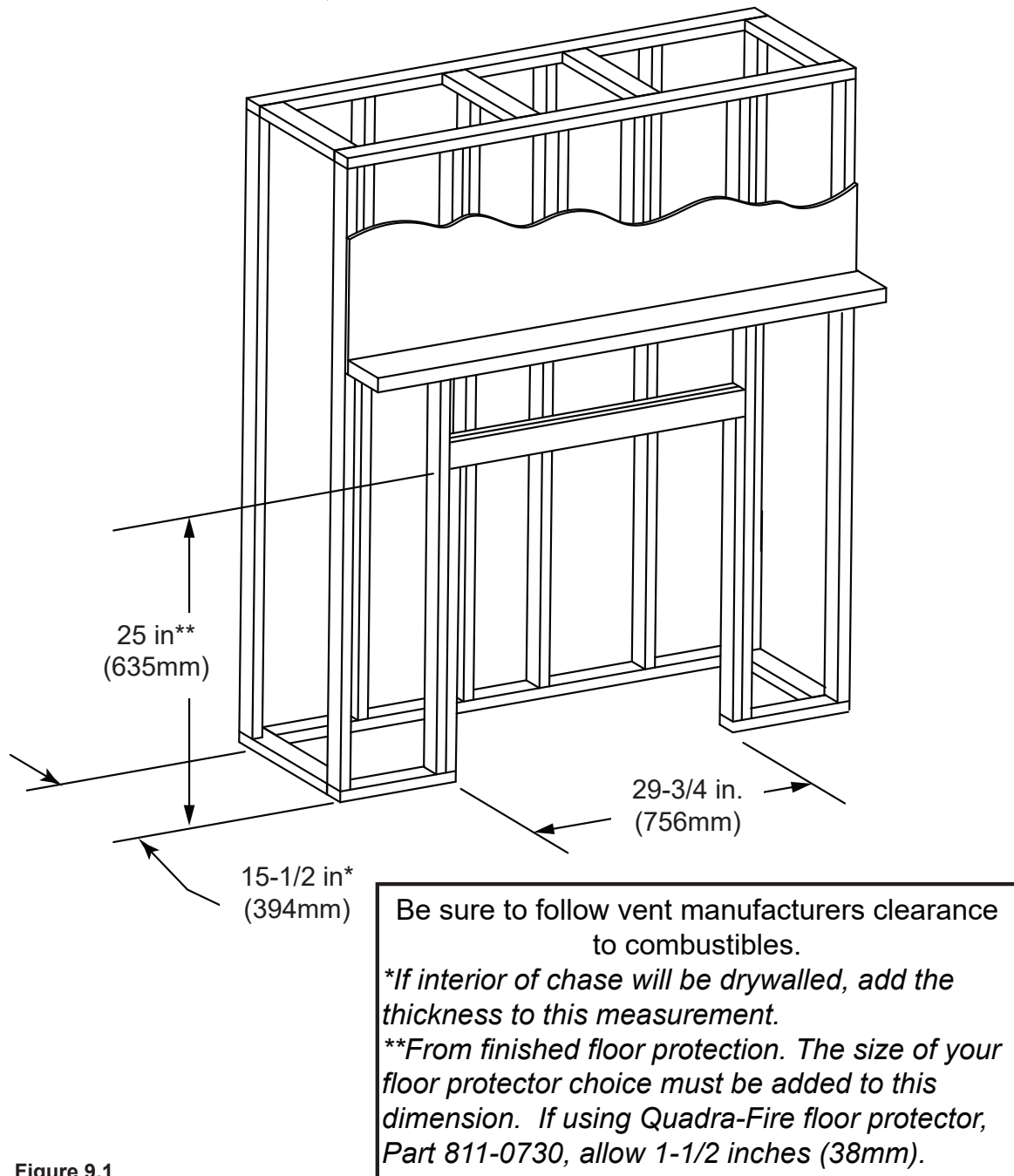

Figure 9.1

**NOTE:** A Quadra-Fire floor protector (Part 811-0730) is available through your dealer to be used as a floor protector for the section under the insert body only. Floor protection to front and sides of insert appliance must be supplied in addition to this part.

**NOTE:** Installing as a built-in will require an 811-0680, Rear Shroud (see page section labeled **Rear Shroud Assembly** starting on **page 20** for details).



**WARNING**



**Fire Risk.**

- Comply with all minimum clearances to combustibles as specified.
- Failure to comply may cause house fire.

**NOTE:**

- Illustrations reflect typical installations and are FOR DESIGN PURPOSES ONLY.
- Illustrations/diagrams are not drawn to scale.
- Actual installation may vary due to individual design preference.

### C. Masonry Chimney and Fireplace Clearances

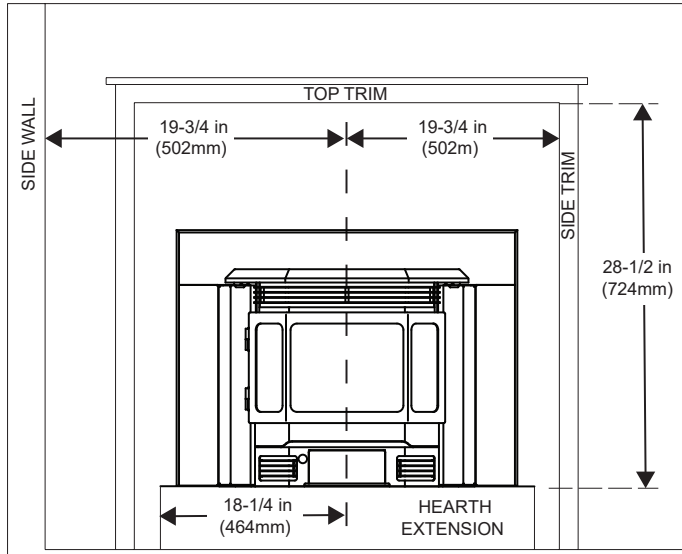

Figure 10.1

**NOTE:** If trim measurement is over 3/4 in (19mm) in depth use mantle or side clearances to combustibles.

### D. Minimum Opening for Masonry & ZC Fireplaces

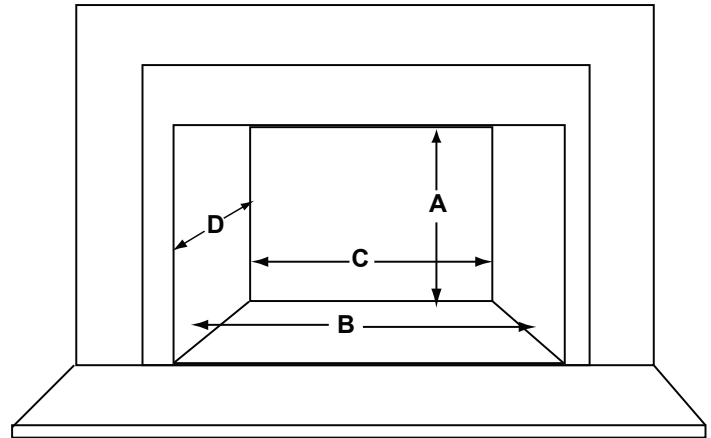

Figure 10.3

Location		Inches	Millimeters
A	Height (Maximum Hopper Adjustment)*	22-1/4	565
	Height (Minimum Hopper Adjustment)*	19-3/4	502
B	Front Width	29-3/4	756
C	Rear Width	22-1/2	572
D	Depth	12-5/8	337

**NOTE:** Minimum opening dimensions include a 1/4" (6mm) clearance around unit.

**\*HEIGHT:** The Classic Bay 1200 Insert has the option of an adjustable hopper from 22 inches for the maximum to 19-1/2 inches for the minimum. Add a 1/4 inch to the adjustment for clearances for any measurement in between the maximum and the minimum height. The Maximum and minimum are already calculated for you in the above table for convenience.

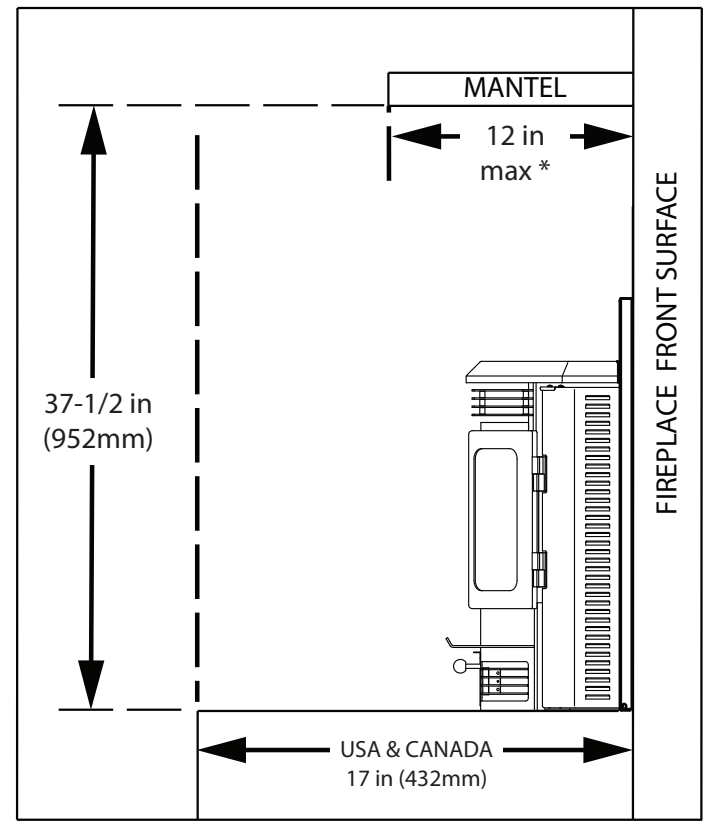



Figure 10.2

### E. Hearth Extension

Use a Type II non-combustible floor protector, extending beneath the appliance and to the front, and to the sides as indicated in sub-section **F. Floor Protection on page 11**. The floor must be non-combustible or otherwise adequately protected from radiant heat given off by the appliance and from sparks and falling embers. A layer of thin brick or ceramic tile over a combustible floor is not sufficient.



**WARNING**



**Fire Risk.**  
Hearth pads must be installed exactly as specified. High temperatures or hot embers may ignite concealed combustibles.



**F. Floor Protection**

**1. Zero Clearance Installations\***

It is necessary to install a floor protection of non-combustible material with a R value of 3.0 (1 inch [25mm] minimum thickness with a “k” value of 0.58) or a 1 inch (25mm) air space between insert base and hearth.

**2. Non-Zero Clearance Installations\***

A non-combustible floor protector is required with a minimum R value of 3.0 (1 inch [25mm] minimum thickness with a “k” value of 0.58) extending 6 inches (153mm) in front of the insert and 8 inches (203mm) to each side of the door opening.

\* See Thermal Resistance: R value.

**NOTE:** A Quadra-Fire floor protector (Part 811-0730) is available through your dealer to be used as a floor protector for the section under the insert body only. Floor protection to front and sides of insert appliance must be supplied in addition to this part.

**Thermal Resistance: R value**

The R value is a measurement of a material’s resistance to heat transfer.

R value is convenient when more than one material is used since you can add the R values together, whereas you can not do this for k value.

The HIGHER the R factor means less heat is being conducted through the non-combustible material to the combustible material beneath it.

The R value of a material must be equal or larger then the required R value to be acceptable.

**NOTE:** Hearth Rug may be used in Suggested Area



**WARNING**



**Fire Risk.**

- Comply with all minimum clearances to combustibles as specified.
- Failure to comply may cause house fire.

**NOTE:** Clearances may only be reduced by means approved by the regulatory authority having jurisdiction

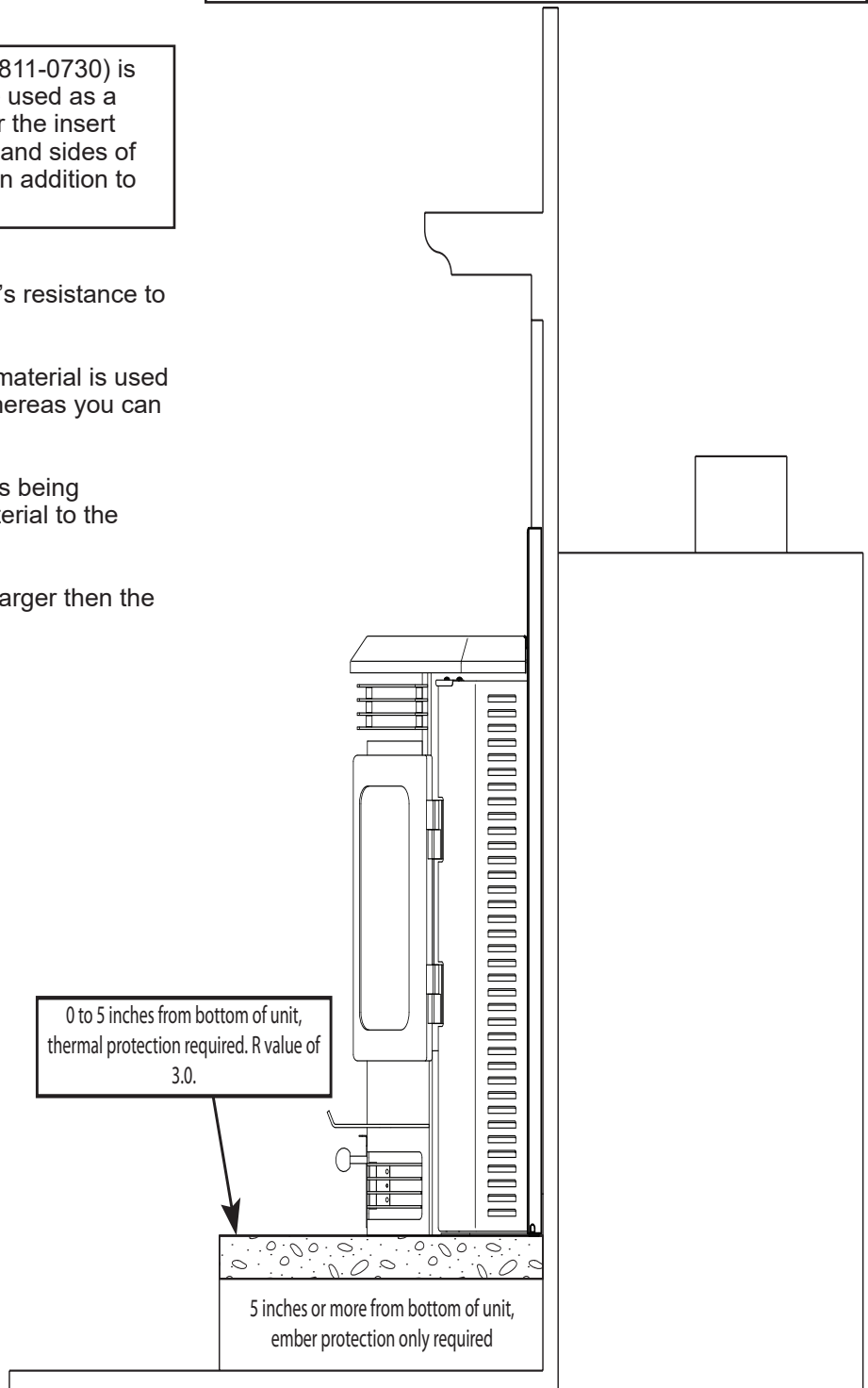

**Figure 11.1**

## G. Installation into a Factory-Built Fireplace

The following modifications are permissible:

- Removal of damper or locked in open position
- Removal of smoke shelf or baffle
- Removal of ember catches
- Removal of fire grate
- Removal of view screen/curtain
- Removal of doors
- Removal of factory-built fireplace floor
- External trim pieces which do not affect the operation of the fireplace may be removed providing they can be stored on or within the fireplace for reassembly if the insert is removed.
- The permanent metal warning label provided must be attached to the back of the fireplace, with screws or nails, stating that the fireplace may have been altered to accommodate the insert, and must be returned to original condition for use as a conventional fireplace (Figure 12.1).

### WARNING

THIS FIREPLACE MAY HAVE BEEN ALTERED TO ACCOMMODATE AN INSERT. IT MUST BE RETURNED TO ITS ORIGINAL CONDITION BEFORE USE AS A SOLID FUEL BURNING FIREPLACE.

250-2061

Figure 12.1

- If the hearth extension is lower than the fireplace opening, the portion of the insert extending onto the hearth must be supported.
- Manufacturer designed adjustable support kit can be ordered from your dealer.

**NOTE:** Refer to chimney liner manufacturer for recommendations on supporting the liner. Installation into fireplaces without a permit will void the listing.

- The firebrick (refractory), glass doors, screen rails, screen mesh and log grates can be removed from a factory-built firebox in order to gain minimum insert opening requirements.
- Any smoke shelves, shields and baffles may be removed from a factory-built firebox if attached with mechanical fasteners.
- The metal floor of the factory-built firebox may be removed to facilitate the installation of the insert only when a 1 inch (25mm) airspace is provided between the insert and the floor of outer wrap.

The following is only one example as there are many different models of factory-built fireplaces.

**NOTE:** This example is for reference only. Any modifications must not compromise the structural integrity or reduce the protection for combustible materials.

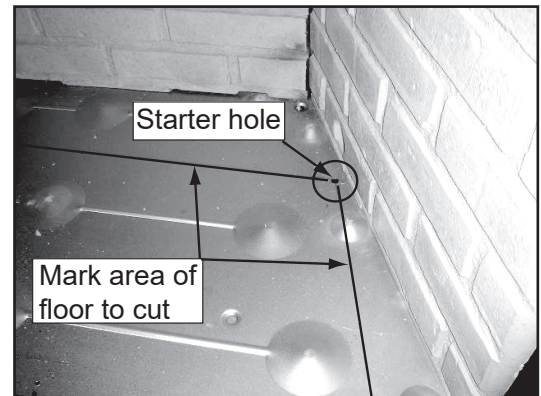

Figure 12.2

Measure and mark the metal floor for cutting. With a drill, make a starter hole in each corner.

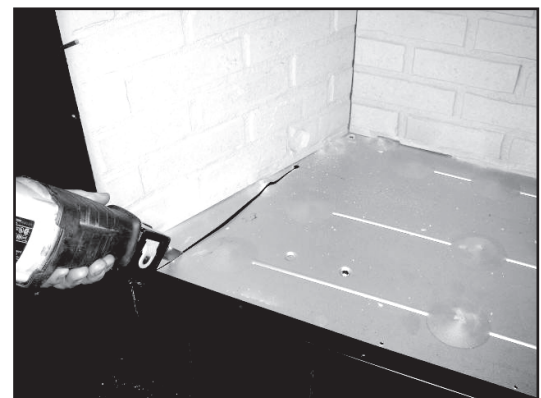

Figure 12.3

Using a saws-all, cut out the floor.

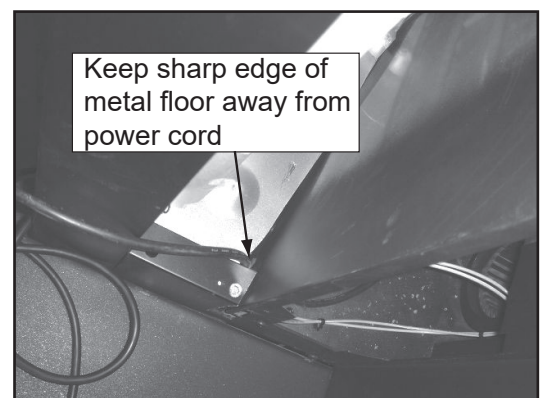

Figure 12.4

Place the insert into the factory-built firebox. Ensure that the power cord can not be damaged by the sharp metal edge. You may need to cut out a notch to accommodate the cord.

## H. Installation into a Masonry Fireplace

All modifications that can be made to a Factory Built Fireplace can be made to a Masonry Fireplace.

In addition DO NOT remove any brick or mortar from the existing fireplace.

### NOTE

It is necessary to permanently seal any opening between the masonry of the fireplace and the facing masonry.



### WARNING

- Removing floor of fireplace must not weaken structure of firebox or reduce protection for combustible materials.
- Final approval of this installation type is contingent upon the appropriate local authority having jurisdiction.

## I. Prefabricated Metal Chimney

The chimney can be new or existing, masonry or prefabricated and must meet the following minimum requirements:

- Must be minimum 6 inch (152mm) inside diameter of high temperature chimney listed to UL 103 HT (2100°F) or ULC-S628.
- Must use components required by the manufacturer for installation.
- Must maintain clearances required by the manufacturer for installation.
- Refer to manufacturers instructions for installation
- This insert is listed to ASTM E 1509-12 Standard and is approved for installation into listed factory-built zero clearance fireplaces listed to UL 127 conforming to the following specifications and instructions:
- The original factory-built clearance fireplace chimney cap must be re-installed after installing the approved chimney liner meeting type UL 103 HT requirements (2100°F) per UL 1777.
- If the chimney is not listed as meeting HT requirements, or if the factory built fireplace was tested prior to 1998, a full height listed chimney liner must be installed from the appliance flue collar to the chimney top.
- The liner must be securely attached to the insert flue collar and the chimney top.
- The air flow of the factory-built zero-clearance fireplace system must not be altered. The flue liner top support attachment must not reduce the air flow for the existing air-cooled chimney system.

- No dilution air is allowed to enter the chimney.
  - a. Secure the fireplace damper in the open position. If this cannot be accomplished, it will be necessary to remove the damper
  - b. Seal damper area of chimney around chimney connector with a high temperature sealant or seal insert against the face of the fireplace.
  - c. Both methods must be removable and replaceable for cleaning and re-installation.



### WARNING



#### Risk of Fire!

Follow venting manufacturer's clearances and instructions when installing venting system.

**NOTICE:** In Canada when using a factory-built chimney it must be safety listed, Type UL103 HT (2100°F) [1149°C] CLASS "A" or conforming to CAN/ULC-S629M, STANDARD FOR 650°C FACTORY-BUILT CHIMNEYS.

# 4 Vent Information

## A. Venting Termination Minimum Requirements

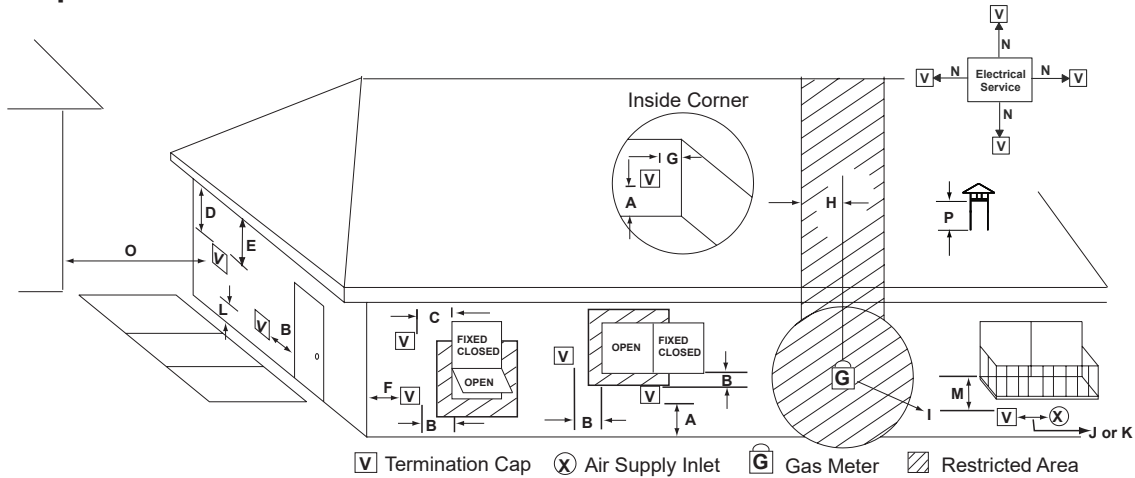

All minimum clearances are listed with an Outside Air Kit (OAK) installed, unless otherwise noted in table below.

<b>A</b>	12 in.	Above Finish Grade (the grade surface must be a non-combustible material)
<b>B</b>	12 in. 48 in. no OAK	Open door or window: below or to the side
<b>B</b>	12 in.	Open door or window: above
<b>C</b>	6 in.	Permanently closed window: above, below or to the side
<b>D</b>	18 in. 36 in. no OAK	Vertical clearance to a ventilated soffit located above the terminal within a horizontal distance of 2 ft from the center-line of the terminal
<b>E</b>	12 in.	Clearance to unventilated soffit
<b>F</b>	12 in.	Clearance to outside corner
<b>G</b>	12 in.	Clearance to inside corner
<b>H</b>	36 in.	Above gas meter/regulator measured from horizontal center-line of regulator
<b>I</b>	36 in. USA 72 in. Canada	Clearance to service regulator vent outlet
<b>J</b>	12 in. 48 in. no OAK	Clearance to non-mechanical air supply inlet to the building or the combustions air inlet to any other appliance
<b>K</b>	10 ft horizontal 3 ft vertical	Clearance to mechanical air supply
<b>L</b>	7 ft.	Above paved sidewalk, paved driveway located on <b>public</b> property
<b>M</b>	12 in.	Under an open veranda, porch, deck or balcony
<b>N</b>	See Note below*	Electric service: above, below or to the side (location must not obstruct or interfere with access)
<b>O</b>	24 in.	Adjacent building, fences and protruding parts of the structure
<b>P</b>	12 in.	Clearance above roof line for vertical terminations

24 in.	Above grass, top of plants, wood or any other combustible
12 in. 36 in. no OAK	Clearance from any forced air intake of other appliance
12 in.	Clearance horizontally from combustible wall
15 in.	Vented directly through a wall, minimum length of horizontal pipe
6 in. horizontal 12 in. vertical	Minimum horizontal or vertical terminations must protrude from wall

**NOTICE:** Termination must exhaust above air inlet elevation.

- It is recommended that at least 60 inches (1.52m) of vertical pipe be installed when appliance is vented directly through a wall. This will create a natural draft, which will help prevent the possibility of smoke or odor venting into the home during a power outage.
- It will also keep exhaust from causing a nuisance or hazard by exposing people or shrubs to high temperatures.
- The safest and preferred venting method is to extend the vent vertically through the roof or above the roof.

**NOTICE: Do NOT Terminate Vent:**

- In any location that will allow flue gases or soot from entering or staining the building.
- In any location which could create a nuisance or hazard.
- In any enclosed or semi-enclosed area such as a carport, garage, attic, crawl space, under a sun deck or porch, narrow walkway.
- Closely fenced area, or any location that can build up a concentration of fumes such as a stairwell, covered breezeway, etc.

**\*NOTE:** Consult local building, fire officials or authorities having jurisdiction. Local codes or regulations may require different clearances.

## B. Avoiding Smoke and Odors

### Negative Pressure, Shut-Down and Electrical Power Failure

To reduce the probability of back-drafting or burn-back in the pellet appliance during power failure or shut down conditions, it must be able to draft naturally without exhaust blower operation.

Negative pressure in the house will resist this natural draft if not accounted for in the pellet appliance installation.

Heat rises in the house and leaks out at upper levels. This air must be replaced with cold air from outdoors which flows into lower levels of the house.

Vents and chimneys into basements and lower levels of the house can become the conduit for air supply and reverse under these conditions.

### Outside Air

An outside air kit is recommended in all installations. The Outside Air Kit must be ordered separately.

Per national building codes, consideration must be given to combustion air supply to all combustion appliances. Failure to supply adequate combustion air for all appliance demands may lead to back-drafting of those and other appliances.

When the appliance is roof vented (strongly recommended):

- The air intake is best located on the exterior wall oriented towards the prevailing wind direction during the heating season.

When the appliance is side-wall vented:

- The air intake is best located on the same exterior wall as the exhaust vent outlet and located lower on the wall than the exhaust vent outlet.

The outside air supply kit can supply most of the demands of the pellet appliance, but consideration must be given to the total house demand.

House demand may consume the air needed for the appliance. It may be necessary to add additional ventilation to the space in which the pellet appliance is located.

Consult with your local HVAC professional to determine the ventilation demands for your house.

### Vent Configurations

When installing a pellet appliance with a horizontal vent configuration the frequency of power outages should be considered:

- Power outages during operation will cause the appliance to immediately turn off and may create conditions where smoke will back draft into the house. In order to reduce the likelihood of smoke back drafting into the house during a power outage, Hearth and Home Technologies strongly suggests:
  - Installing the pellet venting with a minimum vertical run of 5 feet (1.52m).
  - Installing the outside air kit at least 4 feet (1.22m) below the vent termination.

To prevent soot damage to exterior walls of the house and to prevent re-entry of soot or ash into the house:

- Maintain specified clearances to windows, doors and air inlets, including air conditioners.
- Vents should not be placed below ventilated soffits. Run the vent above the roof.
- Avoid venting into alcove locations.
- Vents should not terminate under overhangs, decks or onto covered porches.
- Maintain minimum clearance of 12 inches (305mm) from the vent termination to the exterior wall. If you see deposits developing on the wall, you may need to extend this distance to accommodate your installation conditions.



### CAUTION

- DO NOT CONNECT THIS APPLIANCE TO A CHIMNEY FLUE SERVICING ANOTHER APPLIANCE.
- DO NOT CONNECT TO ANY AIR DISTRIBUTION DUCT OR SYSTEM.



### C. Negative Pressure



#### WARNING

##### Risk of Asphyxiation!

Negative pressure can cause spillage of combustion fumes and soot.

Negative pressure results from the imbalance of air available for the appliance to operate properly. It can be strongest in lower levels of the house.

##### Causes include:

- Exhaust fans (kitchen, bath, etc.)
- Range hoods
- Combustion air requirements for furnaces, water appliances and other combustion appliances
- Clothes dryers
- Location of return-air vents to furnace or air conditioning
- Imbalances of the HVAC air handling system
- Upper level air leaks such as:
  - Recessed lighting
  - Attic hatch
  - Duct leaks

##### To minimize the effects of negative air pressure:

- Install the outside air kit with the intake facing prevailing winds during the heating season
- Ensure adequate outdoor air for all combustion appliances and exhaust equipment
- Ensure furnace and air conditioning return vents are not located in the immediate vicinity of the appliance
- Avoid installing the appliance near doors, walkways or small isolated spaces
- Recessed lighting should be a “sealed can” design
- Attic hatches weather stripped or sealed
- Attic mounted duct work and air handler joints and seams taped or sealed

### D. Draft

Draft is the pressure difference needed to vent an appliance successfully. When an appliance is drafting successfully, all combustion byproducts are exiting the home through the chimney.

Install through the warm airspace enclosed by the building envelope. This helps to produce more draft, especially during lighting and die-down of the fire.

##### Considerations for successful draft include:

- Preventing negative pressure
- Location of appliance and chimney

**NOTICE:** Hearth & Home Technologies assumes no responsibility for the improper performance of the chimney system caused by:

- Inadequate draft due to environmental conditions
- Down drafts
- Tight sealing construction of the structure
- Mechanical exhausting devices

### E. Chimney and Exhaust Connection

**NOTE:** The appliance exhaust outlet is designed to accommodate 3 inch venting. Use of 4 inch venting requires the use of a 3-to-4 inch exhaust vent increaser in addition to any other venting components needed, sold separately.

1. **Chimney & Connector:** Use 3 or 4 inch (76-102mm) diameter type “L” or “PL” venting system. It can be vented vertically or horizontally.
2. **Mobile Home:** Approved for all Listed pellet vent. A Quadra-Fire Outside Air Kit must be used with manufactured home installations.
3. **Install vent at clearances specified by the vent manufacturer.**
4. Secure exhaust venting system to the appliance with at least 3 screws. Also secure all connector pipe joints with at least 3 screws through each joint.
5. **DO NOT INSTALL A FLUE DAMPER IN THE EXHAUST VENTING SYSTEM OF THIS Appliance.**
6. **DO NOT CONNECT THIS Appliance TO A CHIMNEY FLUE SERVING ANOTHER APPLIANCE.**

**NOTE:** All pipe must be welded seam pipe whenever possible. Seal pipe joints with high temperature silicone (500°F [260°C] minimum rated only).

**NOTE:** If burning shelled field corn, you must use approved venting specifically designed for corn. Follow the instructions from the venting manufacturer.



#### WARNING

USE ONLY RECOMMENDED VENTING COMPONENTS; OTHERWISE MAKESHIFT PARTS MAY RESULT IN PROPERTY DAMAGE, PERSONAL INJURY, OR DEATH.



### F. Equivalent Feet of Pipe

The table below can help you calculate the equivalent feet of pipe which is a method used to determine pellet vent size (Figure 17.1).

WARNING



Vent surfaces get HOT, can cause burns if touched. Non-combustible shielding or guards may be required.

### Example of 3 Elbow-Rear Vent Termination Calculation

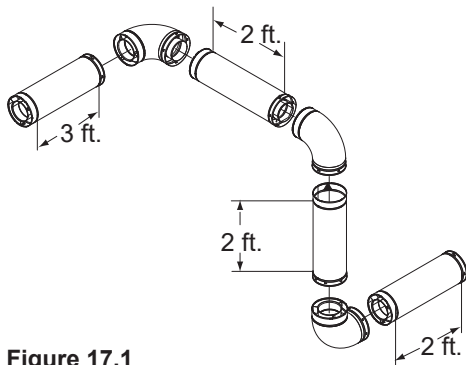

Figure 17.1

Pellet Venting Component	# of Elbows	Feet of Pipe	Multiplied By	Equivalent Feet	Components Equivalent Feet
90° Elbow or Tee	3		X	5	15
45° Elbow			X	3	
Horizontal Pipe		7	X	1	7
Vertical Pipe		2	X	0.5	1
Total Equivalent Feet					23

**NOTE:** This is a generic example and is not intended to represent any specific fuel type.

### G. Pipe Selection Chart

The chart will help you in determining proper venting size according to the equivalent feet of pipe calculated previously and the altitude above sea level of this installation (Figure 17.2).

1. Locate the calculated equivalent feet of pipe on the vertical left side of the chart.
2. Move to the right horizontally on the chart until you reach your altitude above sea level.
3. If you fall below the diagonal line, 3 or 4 inch (76 to 102mm) pipe may be used.
4. If it is anywhere above the diagonal line, a 4 inch (102mm) diameter pipe is required.

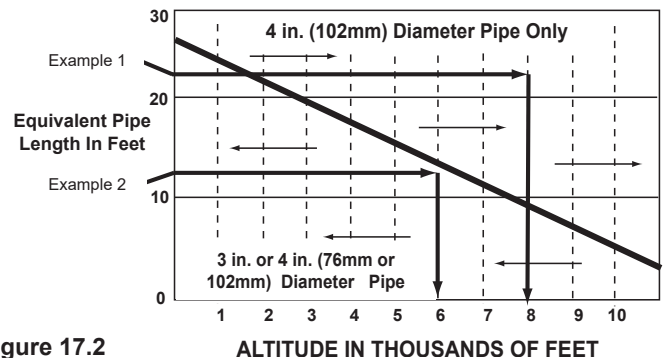



Figure 17.2

- **Example 1:** If the equivalent length of pipe is 23 feet (7m) with altitude of 8,000 feet (2438m) you must use 4 inch (102mm) diameter type “L” or “PL” vent.
- **Example 2:** If the equivalent length of pipe is 12 feet (3.7m) with altitude of 6,000 feet (1829m) you may use 3 or 4 inch (76 to 102mm) diameter type “L” or “PL” vent.

**NOTICE:** A 90° elbow is 5 times as restrictive to the flow of exhaust gases under positive pressure as 1 foot (305mm) of horizontal pipe. A foot of horizontal pipe is twice as restrictive as a foot of vertical pipe.

WARNING



**Risk of Fire!**

- Only LISTED venting components may be used.
- NO OTHER vent components may be used.
- Substitute or damaged vent components may impair safe operation.

WARNING





**Risk of Injury or Property Damage.**

- Improper installation, adjustment, alteration, service or maintenance can cause injury or property damage.
- Refer to the owner’s information manual provided with this appliance.
- For assistance or additional information consult a qualified installer, service agency or your dealer.

# 5 Venting Systems

## A. Full Reline With Outside Air - Horizontal

	<b>CAUTION</b>
Never draw outside combustion air from: <ul style="list-style-type: none"> <li>• Wall, floor or ceiling cavity</li> <li>• Enclosed space such as an attic or garage</li> </ul>	

	<b>WARNING</b>
	<b>Fire Risk.</b> Inspection of Chimney: <ul style="list-style-type: none"> <li>• Masonry chimney must be in good condition.</li> <li>• Meets minimum standard of NFPA 211</li> <li>• Factory-built chimney must be a minimum 6 inch (152mm) UL103 HT.</li> </ul>

NOTE: Use metal plate around exhaust vent pipe and seal all edges with non-flammable insulation such as mineral wool or ceramic.

Do not use high temperature caulking materials to seal any edge to prevent future serviceability.

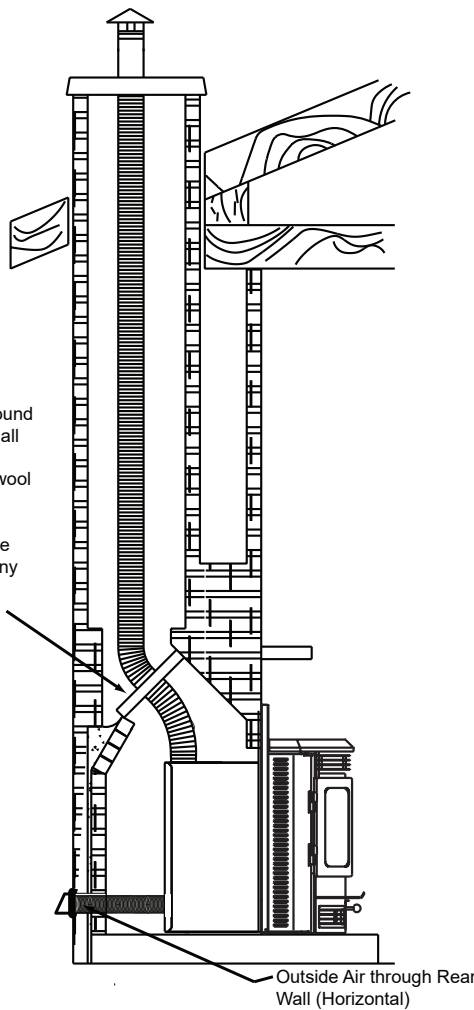

Figure 18.1

**NOTE:** In Canada, where passage through a wall or partition of combustible construction is desired, the installation shall conform to CAN/CSA-B365.

**NOTE:**

- Illustrations reflect typical installations and are FOR DESIGN PURPOSES ONLY.
- Illustrations/diagrams are not drawn to scale.
- Actual installation may vary due to individual design preference.

**B. Full Reline With Outside Air - Vertical**

**NOTE:** Check clearances carefully for this type of installation to ensure adequate room for outside air venting.

**NOTE:** In Canada only a full reline is allowed per ULC S628, ORD ULC C1482-M1990.



**CAUTION**

Check building codes prior to installation.

- Installation **MUST** comply with local, regional, state and national codes and regulations.
- Consult local building, fire officials or authorities having jurisdiction about restrictions, installation inspection, and permits.

**NOTE:** In Canada this fireplace insert must be installed with a continuous chimney liner extending from the fireplace insert to the top of the chimney. The chimney liner must conform to the Class 3 requirements of CAN/ULC-S635, Standard for Lining Systems for Existing Masonry or Factory-Built Chimneys and Vents, or CAN/ULC-S640, Standard for Lining Systems for New Masonry Chimneys.

NOTE; Use metal plate around exhaust vent pipe and seal all edges with non-flammable insulation such as mineral wool or ceramic.

Do not use high temperature caulking materials to seal any edge to prevent furture serviceability.

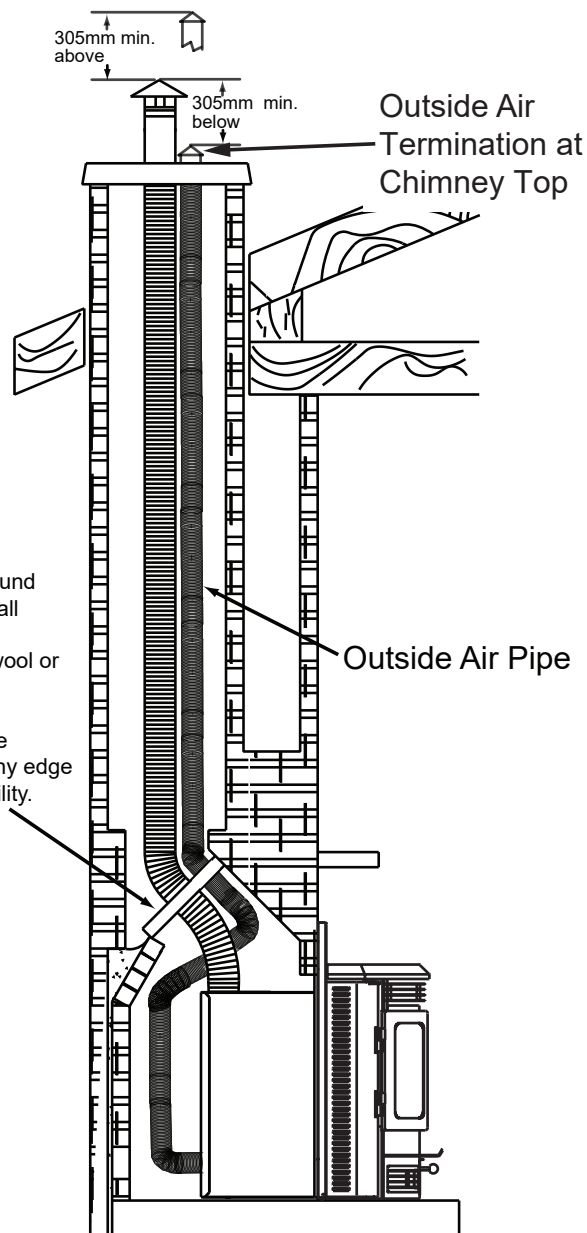

Figure 19.1

# 6 Appliance Set-Up

## A. Rear Shroud Installation

**Tools Required:** Electric drill, #26 drill bit, Phillips screwdriver, 3/8 inch wrench, and 7/16 inch socket wrench.

Needed to complete installation of the Rear Shroud Assembly; 811-0680, will need to purchase one of the following kits:

3 Inch Top Vent Adapter (811-0660)	<b>or</b>	4 Inch Top Vent Adapter (811-0670)
------------------------------------	-----------	------------------------------------

**Do not drill any holes into the appliance until the shroud assembly is attached to the appliance via screws completely; this will ensure the holes line up between the appliance and the shroud assembly.**

1. Remove the top vent adapter from the vertical exhaust transition pipe (Figures 20.1 and 20.2).

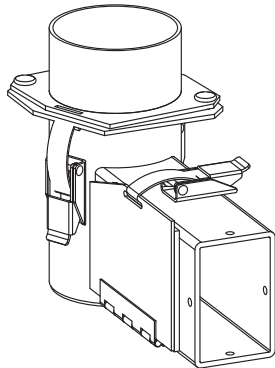

Figure 20.1

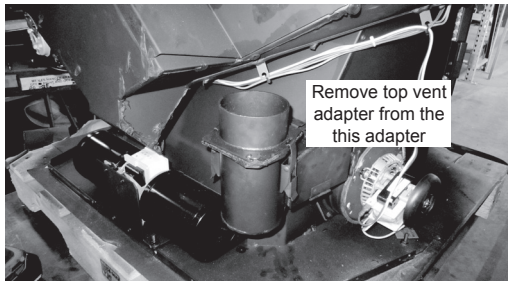

Figure 20.2

Note for the follow step verify the use of the correct hole placement for the filler piece attachment.

2. Using a Phillips head screwdriver and two screws to attach Filler Bracket (Figure 20.3).



Figure 20.3



3. Using a 3/8-inch wrench and 7/16-inch socket wrench fasten Rear Shroud Top Vent to the exhaust transition with two bolts and two nuts. Secure with two clamps from the appliance (Figures 20.4 and 20.5).

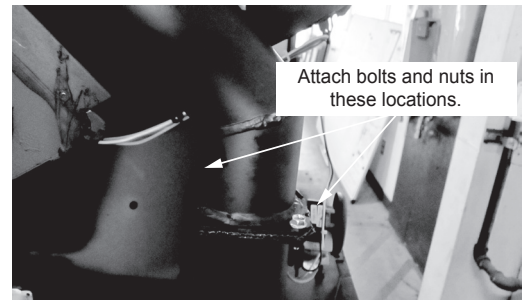

Figure 20.4

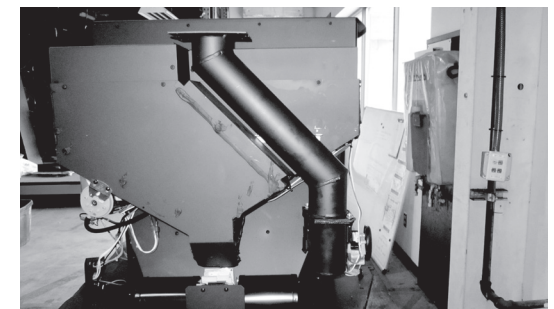

Figure 20.5



4. Install the left shroud panel corner; 2 screws into back of hopper and 1 screw down into the filler piece (**Figure 21.1**).

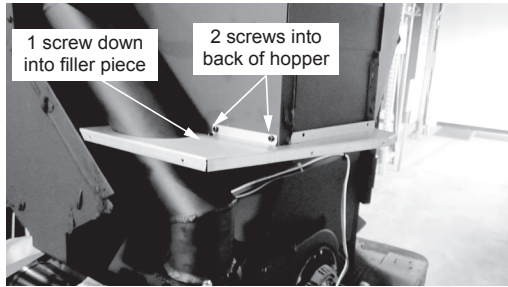

Figure 21.1

5. Install the Rear Panel using six screws (**Figure 21.2**).

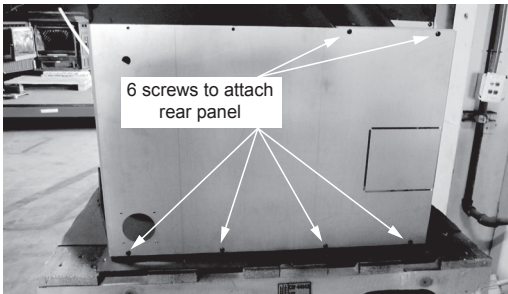

Figure 21.2

6. Install the cover plate over the top vent opening using 4 screws (**Figure 21.3**).

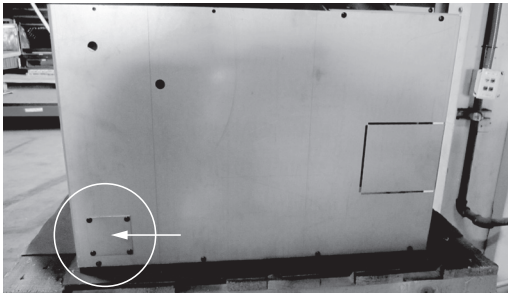

Figure 21.3

7. Attach the left shroud panel using eight screws (**Figure 21.4**).

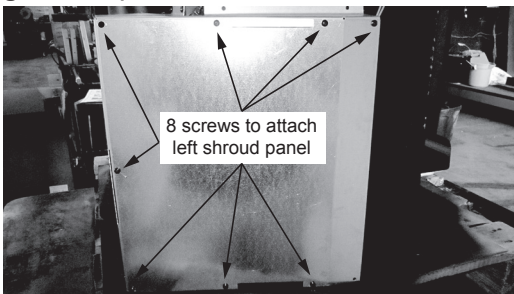

Figure 21.4

8. Assemble the right shroud panel corner and the right shroud panel using 3 screws (**Figure 21.5**).

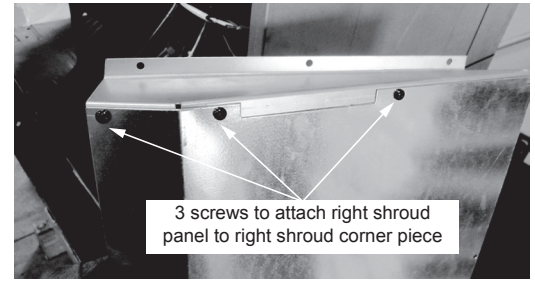

Figure 21.5

9. Attach the right panel assembly using 4 screws to appliance (**Figure 21.6**).

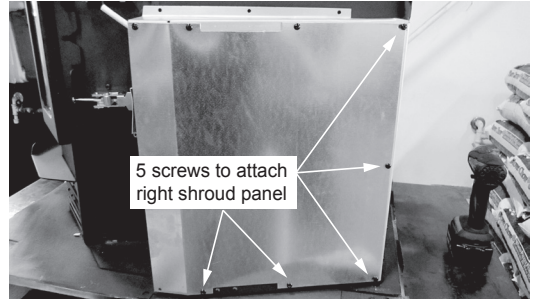

Figure 21.6

10. Using the electric drill with #26 drill bit; drill 3 holes into the hopper. Add three screws to secure shroud assembly to the appliance (**Figure 21.7**).

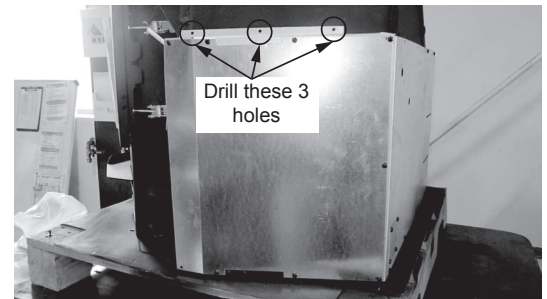

Figure 21.7

11. Using the electric drill with #26 drill bit; drill 2 holes into the back of the hopper. Add two screws to secure shroud assembly to the appliance (**Figure 21.8**).

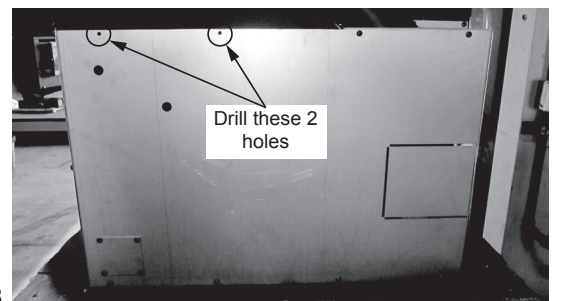

Figure 21.8

12. Using the electric drill with #26 drill bit; drill 2 holes into the left side of the hopper. Add two screws to secure shroud assembly to the appliance (Figure 22.1).

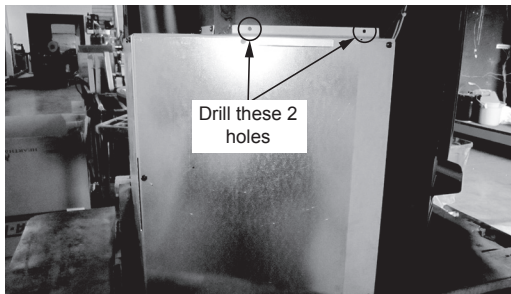

Figure 22.1

13. Attach appropriate the top vent adapter; either 3 inch or 4 inch depending on size of vent pipe using for your application. Attach this to the top of Rear Shroud Top Vent (Figures 22.2 and 22.3).

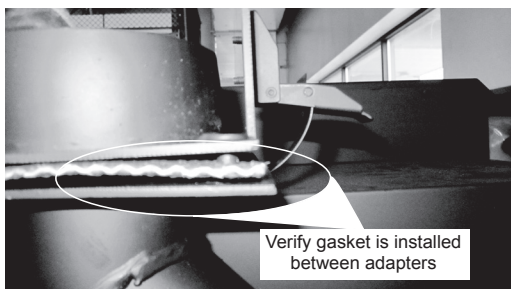

Figure 22.2



Figure 22.3

## B. Outside Air Kit Instructions

**NOTE:** A Quadra-Fire outside air kit; 811-0872, is available through your Quadra-Fire Dealer to be used as a the outside air option, but is required for mobile home installations. See page 26 Section 7 Mobile Home Installation for more details.

**Parts need from the kit:** 1 piece of flex hose, 2 hose clamps, trim ring, and 1 termination cap assembly (See Figure 21.5) and 8 screws.

**Tools Needed:** Phillips head screwdriver; hole saw or jig saw.

1. Measure distance from floor to air vent opening in appliance and mark location on wall.
2. Use saw to cut opening in wall. Cut a 2-1/2 to 3 inches (64-76mm) opening on inside wall and a 3 to 3-1/2 inch (76-89mm) opening on outside of house.
3. Use hose clamp to secure flex pipe to collar assembly.
4. Slide trim ring over flex pipe and run pipe through wall.
5. Attach hose to outside termination cap with second hose clamp.
6. Secure termination cap to outside surface.
7. Secure trim ring to interior wall.



### CAUTION

**Never draw outside combustion air from:**

- Wall, floor or ceiling cavity
- Enclosed space such as an attic or garage

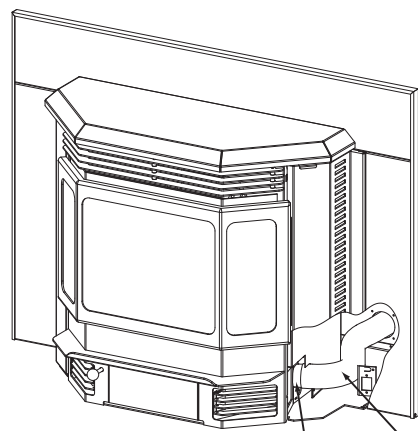

Attach hose clamp to intake air collar

Outside air flex pipe

Figure 22.4

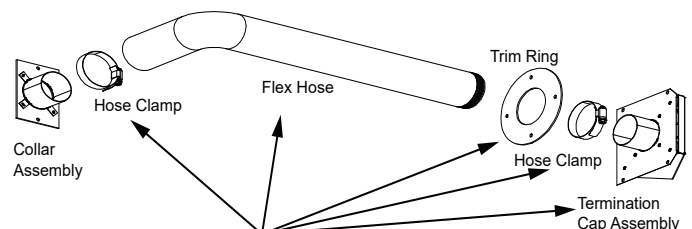

Figure 22.5 Outside Air Kit, 811-0872



### C. Adjustable Hopper Options

Depending on your installation, the hopper can be adjusted down 2-1/2 inches (64mm) and will decrease in capacity from 75lbs to 60lbs.

#### To adjust hopper:

1. Using a Phillips head screwdriver, remove all the screws from the top of the hopper securing the top hopper piece to the bottom hopper piece and insert body.
2. Adjust downward 2-1/2 inches (64mm).
3. Mark location for new holes and drill new holes.
4. Secure hopper pieces together using screws removed in step one.
5. See drawing on page 8, **Figures 8.1 and 8.2.**

### D. Grill Installation

1. Remove grill from packaging.
2. Lift top up.
3. Align the 3 holes in the insert with the holes in the grill.
4. Use a Phillips screwdriver to secure in place. It will be necessary to go through the hole in the bag support shelf to gain access to the screw (**Figure 23.1**).
5. Lower the top into position.

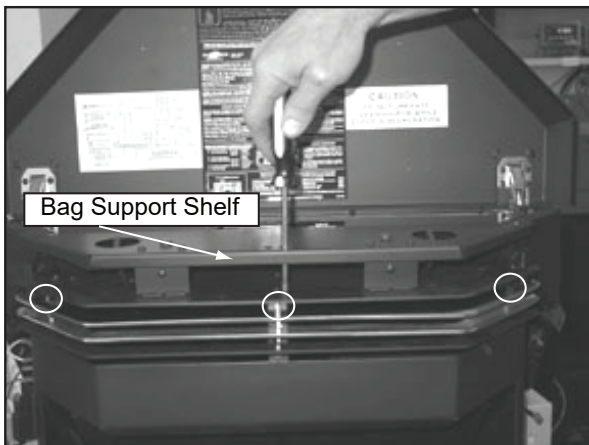

Figure 23.1

### E. Optional Log Set Placement Instructions



#### CAUTION

Logs are FRAGILE. Use extreme care when handling or cleaning logs.

1. Place the front log in first as shown in **Figure 23.2** charred area surrounding fire pot.
2. Set the left and right logs onto the front log, placing the holes in the base of the left and right logs over the locating pins in the front log (**See Figure 23.3**). Ensure that the charred ends are facing the fire pot.

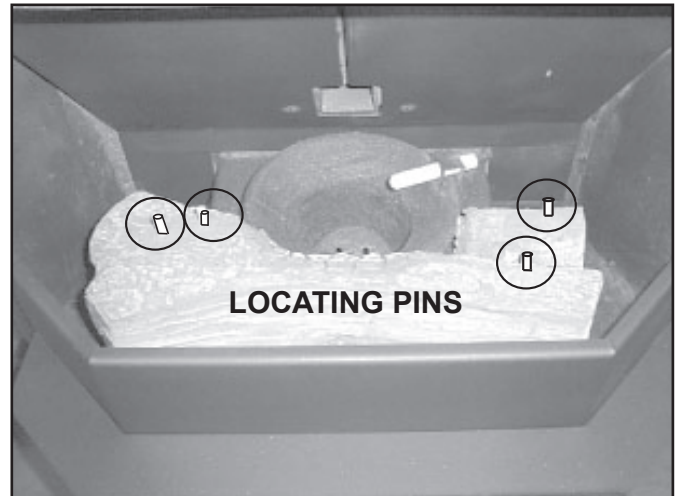

Figure 23.2

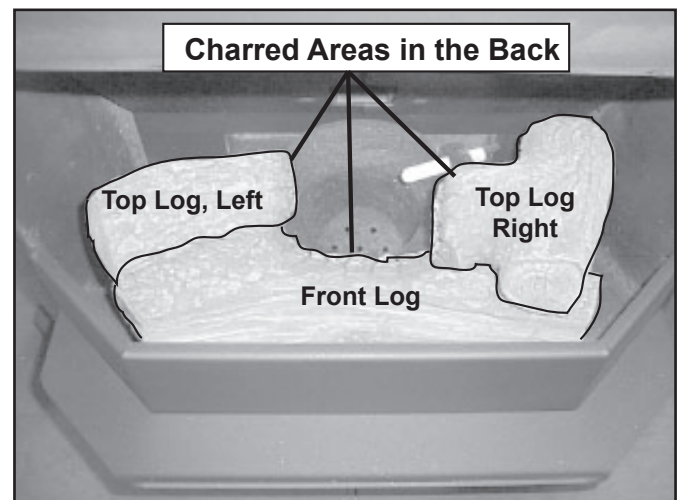

Figure 23.3

**NOTE:** Due to the abrasive nature of a pellet appliance fire, the logs are not covered under warranty. Any placement variation other than shown here can cause excessive heat and shall void the appliance warranty.

## F. Adjustable Hearth Support

Size: 9"D x 45"W, 2" to 10" Height Adjustment

**Included in Kit:** (1) trim top, (1) trim front, (2) trim sides, double-sided tape (already installed)

**Tools Needed:** Phillips head screwdriver, sheet metal shears, measuring tape, gloves

1. The 10 screws on each set of scissors will already be loose when shipped (**Figure 24.1**).
2. Expand scissors to desired height. Tighten screws to hold in place using Phillips head screwdriver (**Figure 24.2**).
3. Measure front and side trims to required height to cover scissors and mark pieces for cutting. Cut excess material from top of trims edge, not bottom. This edge will be sharp; wear gloves to prevent injury to your hands (**Figure 24.3**).
4. Using sheet metal shears, cut trim along the marked edge. The cut edge fits under lip of top trim, so it allows for some variance in your straight edge.
5. The double-sided tape that holds front and side trims to scissors has a powerful bonding adhesive. Adjustments are extremely difficult once trim has adhered to tape. Do a dry run first without removing paper from tape.
6. Place cut edge of trim under top lip and into position on scissors. Place side pieces on first and then front piece. The front piece overlaps side pieces.
7. Once you are satisfied with the positioning, remove trim and set aside.
8. Remove the paper from double-sided tape that is to accept trim side. Align side and then press hard against tape to secure side piece. Repeat for other side. Install front trim piece last.
9. There are 3 holes in the back flange of the top to secure it to the wall if necessary. Use the appropriate fastener for the type of wall material, i.e., brick, sheet rock, etc.

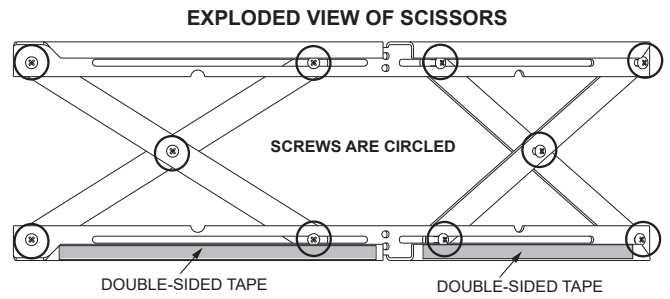

Figure 24.1

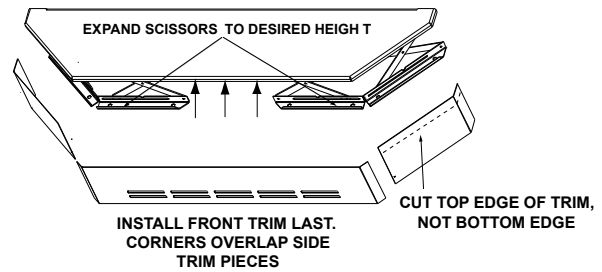

Figure 24.2

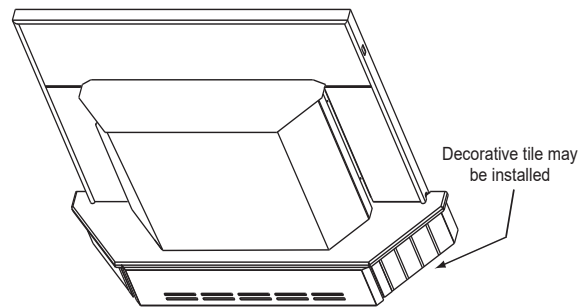

Figure 24.3

**NOTE:** 3/8 inch (9.5mm) thick tile or like material can be cut to size and fit under lip of top trim edge for a decorative touch (**Figure 24.3**).

**WARNING**

Sheet metal trim edges will be sharp. For safety purposes wear gloves. Injury can occur.

### G. Panel and Trim Set

**Standard Size: 30 inches H x 40 inches W  
(762mm x 1016mm)**

**Large Size: 33 inches H x 50 inches W  
(838mm x 1270mm)**

**Included in Kit:** 2 side panels, 1 top panel, 2 side trim, 1 top trim, 2 corner brackets and fastener package.

**Tools Needed:** Phillips and flat head screwdrivers.

1. Unpack and lay out parts face down (flanges up) on a non-abrasive surface.
2. Install (1) 8-32 x 3/8 inch screw into bottom tab of side panel **Figure 25.1**.
3. Set the large hole at bottom of side curtain over screw installed in **Figure 25.2**.
4. Stand assembly on end and attach and install (1) 8-32 x 3/8 inch screw through tab in side panel and curtain **(Figure 25.3)**.
5. Align top panel to side panel setting clearance hole over screw head in side panel/curtain assembly. Install (2) 8-32 x 3/8 inch screws through holes in side panel into top panel **(Figure 25.4)**. Complete for both sides.

**NOTE:** \*Right and left side curtains are shipped with the insert.

6. Hold side curtains in open position and lower panel set over insert setting lower edge of top panel in slot between hopper lid and panel support as shown in **Figure 25.5**. Place existing screw head into locator hole in floor of insert **(Figure 25.6)**.
7. Lift hopper lid and press down on panel top while installing (4) 8-32 x 3/8 inch screws into holes in panel support. (If screws have been factory installed, tighten to secure panel to panel support.) Return hopper lid to closed position **(Figure 25.7)**.
8. Install a corner bracket on each side trim piece. Slide brackets into top trim from each side and secure with flathead screwdriver **(Figure 25.8)**. Attach trim assembly to panel set as follows:
  - a. Ensure that brackets face towards the back.
  - b. Align trim assembly to panel set sides and slide down.

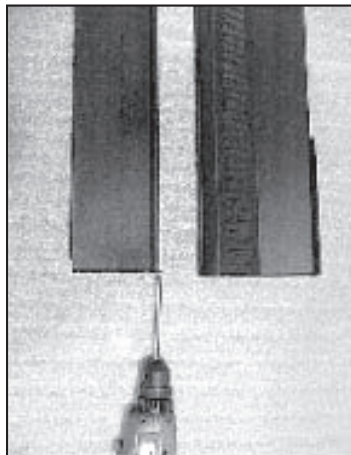

Figure 25.1

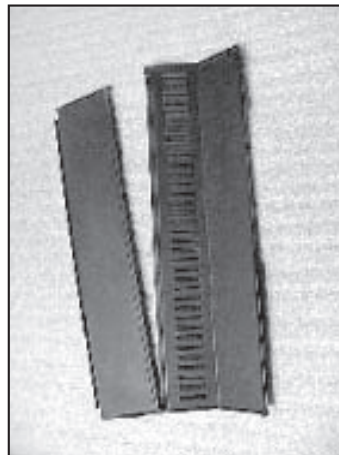

Figure 25.2

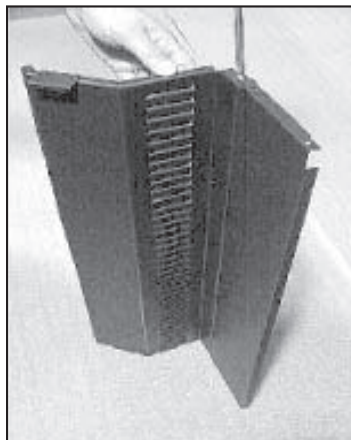

Figure 25.3



Figure 25.4



Figure 25.5

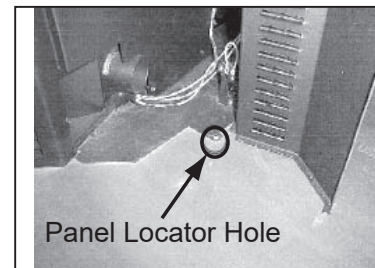

Figure 25.6

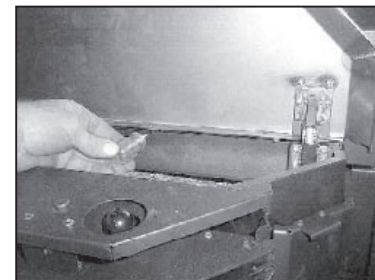

Figure 25.7

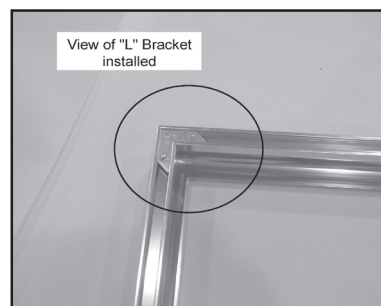

Figure 25.8

## H. Thermostat Installation and Operation

The kit comes with a programmable wall thermostat and 25' of thermostat wire. If you need to run more than 25' make sure you use a continuous strand of 18 to 22 gauge thermostat wire. For optimum performance your thermostat should be:

- Mounted on an inside wall, approximately 5' above the floor
- Do not locate where there is poor air circulation such as in a corner, alcove, behind doors, bookcase or other objects
- Located away from drafts, direct sunlight, above a lamp, television, radiator, a wall next to a window, or direct heat from the appliance
- Avoid damp environments as this can lead to corrosion that may shorten thermostat life
- If painting or construction work around, cover the thermostat completely or wait until work is complete before installation.

**CAUTION**

**Shock hazard.**

- Do NOT remove grounding prong from plug.
- Plug directly into properly grounded 3 prong receptacle.
- Route cord away from appliance.
- Do NOT route cord under or in front of appliance.

1. Separate the body of the thermostat from the mounting plate by gently pulling the two pieces apart (**Figure 26.1**)

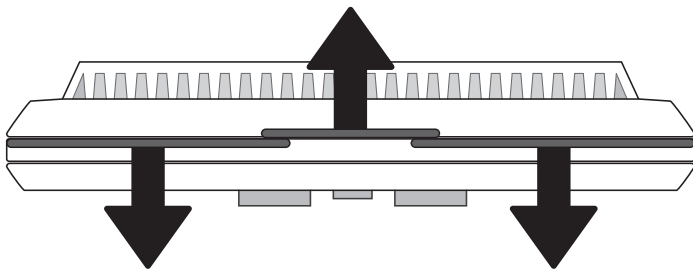

Figure 26.1

2. Use a drill with either a 3/16 drill bit for drywall or a 7/32 drill bit for plaster drill holes.
3. Using a hammer tap in wall anchors.
4. Route the wires through the opening in the base plate, and hold the base against the wall while aligning up to the holes. Attach base plate using a Phillips head screwdriver and two screws.
5. Connect your thermostat wire to the W and R terminals (**Figure 26.2**).

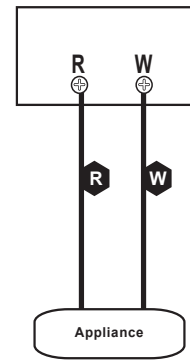

Figure 26.2

**NOTE:** Ensure bare wire ends are held ALL the way into the terminal block while the screws are being tightened.

6. There are two **AA ALKALINE ONLY** batteries already installed into the thermostat; to activate, remove black plastic tab that is located inside the battery compartment.

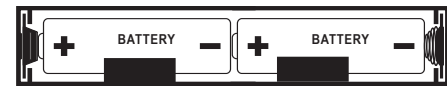

Figure 26.3

7. Snap the thermostat to the base plate.

### CONNECT THERMOSTAT WIRES TO APPLIANCE:

There is a 4 screw terminal block located on the back lower left corner of the stove directly above the power cord inlet. The center 2 screws are for the thermostat wires (**Figure 26.4**).

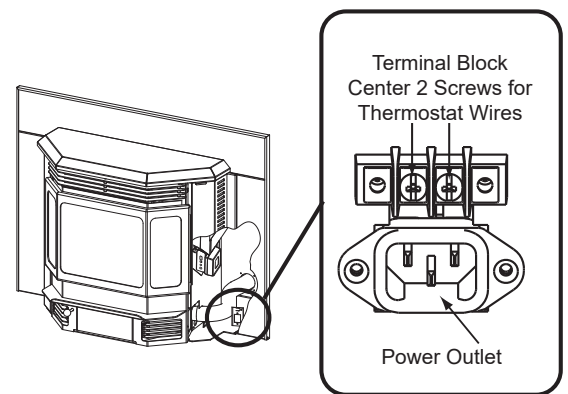

Figure 26.4

**CAUTION**

**Shock hazard.**

- Do NOT remove grounding prong from Plug directly into properly grounded 3 prong receptacle.
- Route cord away from appliance.
- Do NOT route cord under or in front of appliance.



# 7 Mobile Home Installation

**You must use a Quadra-Fire Outside Air Kit 811-0872 for installation in a mobile home.**

1. An outside air inlet must be provided for the combustion air and must remain clear of leaves, debris, ice and/or snow. It must be unrestricted while the appliance is in use to prevent room air starvation which causes smoke spillage. Smoke spillage can also set off smoke alarms.
2. The combustion air duct system must be made of metal. It must permit zero clearance to combustible construction and prevent material from dropping into the inlet or into the area beneath the dwelling and contain a rodent screen.
3. The appliance must be secured to the mobile home structure by bolting it to the floor (using lag bolts). Use the same holes that secured the appliance to the shipping pallet.
4. The appliance must be grounded with #8 solid copper grounding wire or equivalent, terminated at each end with an NEC approved grounding device.
5. Refer to Clearances to Combustibles and floor protection requirements on page 8 for listings to combustibles and appropriate chimney systems.
6. Use silicone to create an effective vapor barrier at the location where the chimney or other component penetrates to the exterior of the structure.
7. Follow the chimney manufacturer's instructions when installing the vent system for use in a mobile home.
8. Installation shall be in accordance with the Manufacturers Home & Safety Standard (HUD) CFR 3280, Part 24.

**PART NUMBER: 811-0872**

	<h2>CAUTION</h2>
<p>THE STRUCTURAL INTEGRITY OF THE MOBILE HOME FLOOR, WALL AND CEILING/ROOF MUST BE MAINTAINED</p> <p><b>Do NOT cut through:</b></p> <ul style="list-style-type: none"> <li>• Floor joist, wall, studs or ceiling trusses.</li> <li>• Any supporting material that would affect the structural integrity.</li> </ul> <p>This appliance is to be connected to a factory-built chimney conforming to <b>CAN/ULC-S629, Standard for 650°C Factory-Built Chimneys</b>. For removal of the chimney for mobile home transportation, contact the proper transportation officials.</p>	

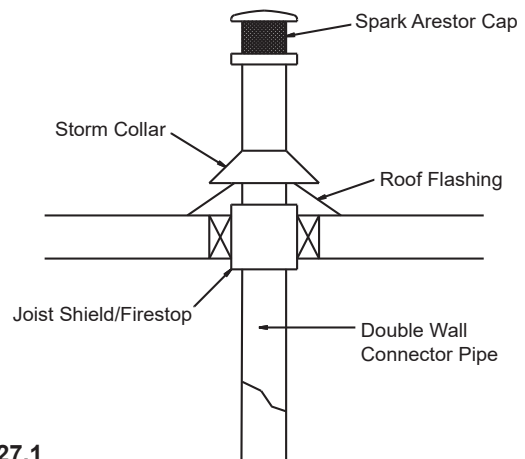





Figure 27.1

	<h2>WARNING</h2>
<p>Products of combustion generate carbon monoxide and different fuels generate different levels. Carbon monoxide:</p> <ul style="list-style-type: none"> <li>• Only use approved fuels in this appliance.</li> <li>• Always keep door shut during operation. Operating this appliance with doors open can allow CO to leak into the home.</li> </ul> <p>CO can kill you before you are aware it is in your home. At lower levels of exposure, CO causes mild effects that are often mistaken for the flu. These symptoms include headaches, dizziness, disorientation, nausea and fatigue. The effects of CO exposure can vary greatly from person to person depending on age, overall health and the concentration and length of exposure.</p>	

	<h2>CAUTION</h2>
<p>Never draw outside combustion air from:</p> <ul style="list-style-type: none"> <li>• Wall, floor or ceiling cavity</li> <li>• Enclosed space such as an attic or garage</li> </ul>	

	<h2>WARNING</h2>
<p><b>It is critical to have a working smoke detector installed in the home of appliance operation.</b></p> <ul style="list-style-type: none"> <li>• Smoke alarms that are properly installed and maintained play a vital role in reducing fire deaths and injuries. Having a working smoke alarm reduces the chance of fire related injuries.</li> </ul>	









Beginning Manufacturing Date: May 2019  
Ending Manufacturing Date: Active

IMPORTANT: THIS IS DATED INFORMATION. Parts must be ordered from a dealer or distributor. **Hearth and Home Technologies does not sell directly to consumers.** Provide model number and serial number when requesting service parts from your dealer or distributor.

**Stocked  
at Depot**

ITEM	DESCRIPTION	COMMENTS	PART NUMBER	
<b>OPTIONAL ACCESSORIES</b>				
	Adjustable Hearth Support - 12 in. X 50 in., 2-10 in. H		ADJSPT-12	
	Damper, 3 Inch - Tall Vertical Installs Only		PEL-DAMP3	<b>Y</b>
	Damper, 4 Inch - Tall Vertical Installs Only		PEL-DAMP4	
	Floor Protector		811-0730	
	Log Set Assembly		811-0592	
	Hose, Alum Flex, 2 Inch X 3 Ft	3 Ft	SRV200-0860	
	Panel Set, Large, W/Nickel Trim	33 in x 50 in.	SP-CB12I3350-NL	
	Bracket, -L-, Trim	Pkg of 2	832-0840	
	Logo, Quadra-Fire	Pkg of 10	7000-649/10	
	Trim, Panel Set, Ots, Nickel		510-5220	
	Panel Set, Large, W/Black Nickel Trim	33 in x 50 in.	SP-CB12I3350-NB	
	Bracket, -L-, Trim	Pkg of 2	832-0840	
	Logo, Quadra-Fire	Pkg of 10	7000-649/10	
	Trim, Panel Set, Ots, Nickel		7019-027	
	Panel Set, Small, W/Nickel Trim	30 in. x 40 in.	SP-CB12I3040-NL	
	Bracket, -L-, Trim	Pkg of 2	832-0840	
	Logo, Quadra-Fire	Pkg of 10	7000-649/10	
	Trim, Panel Set, Std, Nickel		510-5210	
	Panel Set, Small, W/Black Nickel Trim	30 in. x 40 in.	SP-CB12I3040-NB	
	Bracket, -L-, Trim	Pkg of 2	832-0840	
	Logo, Quadra-Fire	Pkg of 10	7000-649/10	
	Trim, Panel Set, Std, Nickel		7019-026	
	Handle, Pullrod		PULLROD-HNDL	
	Shroud, Rear		811-0680	
	Smart-Batt II		841-0970	
	Smart-Stat II		841-0960	
	Thermostat, Programmable		PROG-STAT	
	Top Vent Adapter, 3"		811-0660	
	Top Vent Adapter, 4"		811-0670	
	Top Vent Kit, Rear Shroud		811-0650	
	Vent Adapter, 3-4"		811-0720	

Additional service part numbers appear on following page.



**CONTACT INFORMATION**

Hearth & Home Technologies  
352 Mountain House Road  
Halifax, PA 17032  
Division of HNI INDUSTRIES

Please contact your Quadra-Fire dealer with any questions or concerns.  
For the number of your nearest Quadra-Fire dealer  
log onto [www.quadrafire.com](http://www.quadrafire.com)

**CAUTION**



**DO NOT DISCARD THIS MANUAL**

Important operating and maintenance instructions included.

• Read, understand and follow these instructions for safe installation and operation.

• Leave this manual with party responsible for use and operation.



**We recommend that you record the following pertinent information for your heating appliance.**

Date purchased/installed: \_\_\_\_\_

Serial Number: \_\_\_\_\_ Location on appliance: \_\_\_\_\_

Dealership purchased from: \_\_\_\_\_ Dealer phone: 1(\_\_\_\_)\_\_\_\_ - \_\_\_\_\_

Notes: \_\_\_\_\_

\_\_\_\_\_

\_\_\_\_\_

This product may be covered by one or more of the following patents: (United States) 5341794, 5263471, 6688302, 7216645, 7047962 or other U.S. and foreign patents pending.

