

Models:

- GO24-IPI-NG or LP-HK
- GO30-IPI-NG or LP-HK
- GO318-IPI-NG or LP-HK
- GO324-IPI-NG or LP-HK
- GO330-IPI-NG or LP-HK







Installation and service of this appliance should be performed by qualified personnel. Hearth & Home Technologies suggests NFI certified or factory-trained professionals, or technicians supervised by an NFI certified professional.

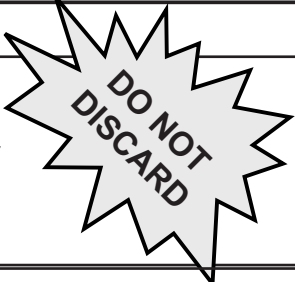

Grand Oak Hearth Kits

Check with your local building code agency before you begin installation to ensure compliance with local codes, including the need for permits and follow-up inspections. If you encounter any problems regarding code approvals, or if you need clarification of any of the instructions contained here, contact the Technical Services Dept., Hearth & Home Technologies Inc., www.hearthnhome.com.

CAUTION	
	<p style="text-align: center;">DO NOT DISCARD THIS MANUAL</p> <ul style="list-style-type: none"> • Important operating and maintenance instructions included. • Read, understand and follow these instructions for safe installation and operation. • Leave this manual with party responsible for use and operation.
	
<p style="text-align: center;">⚠ WARNING</p>  <p>If the information in these instructions is not followed exactly, a fire may result causing property damage, personal injury, or death.</p> <ul style="list-style-type: none"> • Do not store or use gasoline or other flammable vapors and liquids in the vicinity of this or any other appliance. • What to do if you smell gas: <ul style="list-style-type: none"> - Do not try to light any appliance. - Do not touch any electrical switch. Do not use any phone in your building. - Immediately call your gas supplier from a neighbor's phone. Follow the gas supplier's instructions. - If you cannot reach your gas supplier, call the fire department. • Installation and service must be performed by a qualified installer, service agency, or the gas supplier. 	<p style="text-align: center;">⚠ WARNING</p>  <p>HOT! DO NOT TOUCH. SEVERE BURNS MAY RESULT. CLOTHING IGNITION MAY RESULT.</p>  <p>Glass and other surfaces are hot during operation and cool down.</p> <ul style="list-style-type: none"> • Keep children away. • CAREFULLY SUPERVISE children in same room as appliance. • Alert children and adults to hazards of high temperatures. • Do NOT operate with protective barriers removed. • Keep clothing, furniture, draperies and other combustibles away.
<p>In the Commonwealth of Massachusetts:</p> <ul style="list-style-type: none"> • This appliance must be installed by a licensed plumber or gas fitter. • The chimney flue damper, when used with gas logs, will be welded open or completely removed. • A CO detector shall be installed in the room where the appliance is installed. 	

NOTE: THE USE OF A THERMOSTAT IS PROHIBITED IN VENTED LOG INSTALLATIONS.

**Read this manual before installing or operating this appliance.
Please retain this owner's manual for future reference.**

Congratulations

Congratulations on selecting a Hearth & Home Technologies gas log set—an elegant and clean alternative to burning wood. The Hearth & Home Technologies gas log set you have selected is designed to provide the utmost in safety, reliability, and efficiency.

As the owner of this new gas log set, you'll want to read and carefully follow all of the instructions contained in this owner's manual. Pay special attention to all cautions and warnings.

This owner's manual should be retained for future reference. We suggest you keep it with your other important documents and product manuals.

The information contained in this owner's manual, unless noted otherwise, applies to all models and gas control systems.

Your new gas log set will give you years of durable use and trouble-free enjoyment. Welcome to the Hearth & Home Technologies family of appliance products!

We recommend that you record the following pertinent information about your gas log set:

Homeowner Reference Information

Model Name: _____ Date purchased/installed: _____

Serial Number: _____ Location on appliance: _____

Dealership purchased from: _____ Dealer phone: _____

Notes: _____

Listing Label Information/Location

The model information regarding your specific gas log set can be found on the rating plate.

Model # → **MODEL NO:**

Serial # → **SERIAL NO: ????**

Gas Type → **GAS TYPE**

INPUT RATING:

MAX. INLET PRESSURE:

MANIFOLD PRESSURE:

PFS US HEARTH AND HOME TECHNOLOGIES
ANGIER, NC 27501

Design complies with ANSI Z21.60-2017 CSA 2.26-2017 decorative appliances for installation in solid-fuel burning fireplaces. The minimum inlet gas supply pressure for the purpose of input adjustment is 7 inches W.C. The minimum size fireplace opening is W x H x D.

WARNING: For installation in a solid-fuel burning fireplace only. The fireplace chimney must have a permanent vent opening to the atmosphere of not less than 38.5 square inches or as determined from the manufacturer's installation instructions.

WARNING: Improper installation, adjustment, alteration, service or maintenance can cause property damage, personal injury or loss of life. Refer to the owner's information manual provided with this appliance. Installation and service must be performed by a qualified installer, service agency or the gas supplier.



California Proposition 65 Warning

WARNING: This product can expose you to chemicals, including carbon black, which is known in the state of California to cause cancer and chromium, which is known in the state of California to cause birth defects or other reproductive harm.

For more information go to: www.P65Warnings.ca.gov

A. Design and Installation Considerations

The Gas Log Hearth Kit consists of the following:

- Log Set (sold separately)
- Burner/Pan Assembly
- Grate Assembly
- Rock Wool
- Sand (NG only)
- Lava Rock
- Damper Stop
- Vermiculite
- Platinum Embers

- Review proper placement of logs, rockwool, lava rock and vermiculite.
- Check the wiring.
- Ensure there are no gas leaks.
- Ensure the flow of combustion and ventilation air is not obstructed (front grilles and vent caps).
- Before installing into a solid fuel burning fireplace, the chimney and firebox should be inspected and cleaned to remove soot, creosote, ashes, paint, bird nests etc.
- Annual examination of the chimney must be performed by a qualified agency to ensure proper ventilation of flue gases created by this appliance.
- Have the chimney and adjacent structure inspected and cleaned by qualified professionals. Hearth & Home Technologies recommends that NFI or CSIA certified professionals, or technicians under the direction of certified professionals, conduct a minimum of an **NFPA 211 Level 2** inspection of the chimney.
- Replace component parts of the chimney and fireplace as specified by the professionals.
- Ensure all joints are properly engaged and the chimney is properly secured.
- Do not allow fans to blow directly into the fireplace. Avoid any drafts that alter burner flame pattern.
- Do not use a blower insert, heat exchanger insert or other accessories not approved for use with this appliance.

B. Tools and Supplies Needed

Tools and supplies normally required for installation:

- Pliers
- Phillips screwdriver
- Tape measure
- Crescent wrenches
- Gas shutoff valve
- Non-corrosive leak check solution
- 3/4 in. wrench, 7/16 in. wrench

WARNING

Improper installation, adjustment, alteration, service or maintenance can cause injury or property damage. Refer to the owner's information manual provided with this appliance. For assistance or additional information consult a qualified installer, service agency or the gas supplier.

C. Important!

- Do not remove any of the attached metal plates, which contain important safety and operating information.
- Keep the appliance area clear and free of all combustible materials, gasoline and other flammable vapors and liquids.
- Any safety screen or guard removed during servicing must be replaced before operation.
- **A qualified service technician must perform installation and repair.** The appliance should be inspected and cleaned annually by a qualified service technician. More frequent cleaning may be required due to excessive lint, dust, pet hair, etc. It is imperative that the control compartments, burners and air passageways are unobstructed during operation.

WARNING



**HOT! DO NOT TOUCH.
SEVERE BURNS MAY RESULT.
CLOTHING IGNITION MAY RESULT.**





Glass and other surfaces are hot during operation and cool down.

- Keep children away.
- **CAREFULLY SUPERVISE** children in same room as appliance.
- Alert children and adults to hazards of high temperatures.
- Keep clothing, furniture, draperies and other combustibles away.

- This appliance must have a screen in place while the appliance is in operation and, unless other provisions for combustion air are provided, the screen shall have an opening for introduction of combustion air.
- Solid fuels shall not be burned in a fireplace where a decorative appliance is installed.
- If glass doors are present, the **glass doors must be fully opened** while appliance is in operation.

 WARNING
Do NOT use this appliance if any part has been under water. Immediately call a qualified service technician to inspect the appliance and to replace any part of the control system and any gas control which has been under water.

 WARNING
 <p>Fire Risk Exhaust Fumes Risk</p> <ul style="list-style-type: none"> • Do NOT use this appliance as a “vent-free” heater.  <p>The flue must be permanently open according to Tables 1 and 2.</p>

D. Appliance Certification

This appliance is design certified by PFS under the **ANSI Z21.60-2017** or **CSA 2.26-2017, Decorative Appliances for Installation in Solid-fuel Burning Fireplaces**. Installation and the provisions for combustion and ventilation air must conform to the **National Fuel Gas Code, ANSI Z223.1/NFPA 54**, or the **CSA B149.1, Natural Gas and Propane Installation Code**.



E. Gas Supply Connection

A 3/8 in. flared fitting has been installed on the gas valve inlet at the factory. Ensure fittings are of the appropriate size and type on the gas line connection. If the tubing has to be cut to length be sure to use the proper cutting and flaring tool. Also, be careful not to crimp the tubing while bending. If the tubing becomes crimped, do not use for installation.

Gas resistant pipe compound must be used on all threaded male connections to ensure a tight seal.

F. Gas Pressure

Proper input pressures are required for optimum appliance performance. Gas line sizing requirements need to be made following **NFPA51**.

 WARNING
 <p>Fire Risk Explosion Risk</p> <p>High pressure will damage valve.</p> <ul style="list-style-type: none"> • Disconnect gas supply piping BEFORE pressure testing gas line at test pressures above 1/2 psig. • Close the manual shutoff valve BEFORE pressure testing gas line at test pressures equal to or less than 1/2 psig. 

- Gas Supply Pressure: Minimum inlet gas supply pressure must be 7.0 in. W.C. for natural gas or 11 in. W.C. for LP gas for the purpose of input adjustment. Maximum inlet gas pressure must not exceed 10.5 in. W.C. for natural gas or 13 in. W.C. for LP gas. The gas line supplying the appliance must be sufficient size to furnish the appropriate supply pressure to the appliance while operating in the “High” setting.
- Pressure tap screws must be closed before turning gas on to the appliance.
- Gas Line Pressure Test: Perform pressure test according to state and local code (if pressure exceeds 1/2 in. psi (3.5 kPa)) before appliance is connected. Be sure to release air pressure from the gas line before connection is made to the appliance. Excessive pressure will damage the gas control and may cause a gas leak.
- Gas Leak Test: Make sure the gas connections are tight. Turn on the gas and coat each joint with a non-corrosive gas leak check solution. Air bubbles will form indicating any leaks. DO NOT USE A FLAME OR ANY TYPE OF IGNITION SOURCE TO CHECK FOR LEAKS. All leaks must be corrected before proceeding with installation.
- The appliance must only be installed in a solid-fuel burning fireplace with the flue damper clamped open according to Tables 1 and 2. The fireplace must be constructed of non-combustible material.
- The minimum permanent free opening (in square inches) that must be provided by the fireplace chimney or damper to vent the flue gases is provided in Tables 1 and 2. If the free opening is smaller than the specified area, do not use this appliance.
- The damper must be removed or fixed in a manner in which will secure it open. Some jurisdictions require the damper to be removed or permanently welded fully open. Check with state and local codes.
- Be sure that the chimney is completely unobstructed to ensure proper ventilation of flue gases including carbon monoxide (CO). CO (a poisonous gas) is tasteless, odorless, colorless and undetectable without proper equipment.
- Refer to Table 3 to determine minimum fireplace opening requirements before proceeding.

G. Negative Pressure

Negative pressure results from the imbalance of air available for the fireplace to operate properly. Causes for this imbalance include:

- Exhaust fans (kitchen, bath, etc.).
- Range hoods.
- Combustion air requirements for furnaces, water heaters and other combustion appliances.
- Clothes dryers.
- Location of return-air vents to furnace or air conditioning.
- Imbalances of the HVAC air handling system.
- Upper level air leaks: recessed lighting, attic hatch opening, duct leaks.

WARNING



Asphyxiation Risk

This appliance produces carbon monoxide (CO).

- The free opening areas (in square inches) of the chimney damper as shown in the following tables must be met.
- User must make sure damper is locked open.
- The installer is responsible to ensure proper ventilation of flue gases before appliance is used.

Fire needs to draft properly for safe operation.

Table 1 for Factory Built Fireplaces

Free Opening Area (in square inches) of Chimney Damper for Venting combustion Products from Decorative Appliances for Installation in Solid Fuel Burning Fireplaces.

Chimney Ht. (Feet)*	GO318 LP Gas	GO318 Natural Gas	GO24 & 324 LP Gas	GO24 & 324 Natural Gas	GO30 & 330 LP Gas	GO30 & 330 Natural Gas
10	35.3	not approved	35.3	not approved	44.2	not approved
15	26.4	38.5	26.4	38.5	32.2	45.4
20	22.1	31.2	22.1	31.2	26.4	37.4
25	18.1	27.3	18.1	27.3	22.9	31.2
30	17.3	24.6	17.3	24.6	20.4	28.3
35	15.9	22.1	15.9	22.1	18.9	25.5
40	15.2	20.4	15.2	20.4	18.1	23.8

Table 2 for Masonary Built Fireplaces

Free Opening Area (in square inches) of Chimney Damper for Venting combustion Products from Decorative Appliances for Installation in Solid Fuel Burning Fireplaces.

Chimney Ht. (Feet)*	GO318 LP Gas	GO318 Natural Gas	GO24 & 324 LP Gas	GO24 & 324 Natural Gas	GO30 & 330 LP Gas	GO30 & 330 Natural Gas
6	49.2	64	49.2	64	56.6	71.4
8	59.7	59.7	45.5	59.7	52.4	66.9
10	54.3	54.3	41.7	54.3	48.2	60.2
15	48.8	48.8	37.7	48.8	43.2	54.1
20	44.4	44.4	34.3	44.4	39.8	49.1
30	40.3	40.3	31.2	40.3	35.9	44.5

* Height is measured from the hearth to the top of the chimney.
Minimum height is 6 ft.

Table 3 for Minimum Fireplace Dimensions

Log Set	Front Opening	Depth	Height	Rear Width	Natural BTU	Propane BTU
GO318	32"	23"	22"	21"	88,000	80,000
GO24	34"	20"	18"	22"	73,000	61,000
GO30	40"	20"	18"	29"	80,000	70,000
GO324	34"	23"	22"	22"	88,000	80,000
GO330	40"	23"	22"	29"	92,000	82,000

H. Inspect the Appliance and Components

- Remove the contents from the carton labeled “Burner”. Attached to the burner are tags identifying the manufacturer name, serial number, model number (including gas log size), BTU ratings, gas type, etc.
- Review the attached tags before proceeding. Ensure that all minimum fireplace dimension requirements are achieved using [Table 3](#) . See Figure 1. Ensure the gas type provided in the fireplace coincide with the gas type marked on the tag.

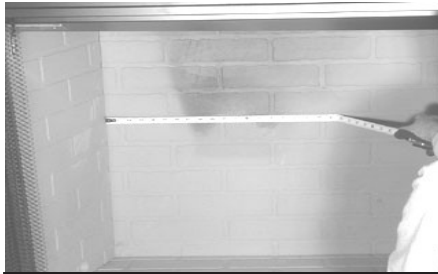
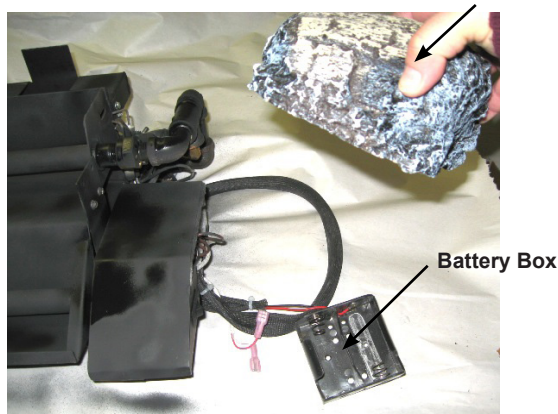

Figure 1 Measure Firebox

- The burner is assembled with the controls installed at the factory and is designed to connect one end of the 3/8 in. supply line before placing inside the fireplace. Ensure the connection is tightened using a 3/4 in. wrench.
- Place the burner towards the rear and center of the fireplace and connect to the gas line. Follow instructions in “F. Gas Pressure” to check for gas leaks.
- IPI models include a battery box which holds 2 “D” size batteries. The battery box should be placed in the right front corner of your fireplace and covered with the log cover as shown in Figure 3.
- An On/Off switch is provided as part of the assembly. It is located on the front right side of the burner assembly as shown in Figure 3A.
- Optional remote control system can be incorporated with this system by connecting the remote system to the connection wires shown in Figure 3A.

Figure 3 Battery Box and Cover (for IPI units only)



Battery Box Cover

Battery Box

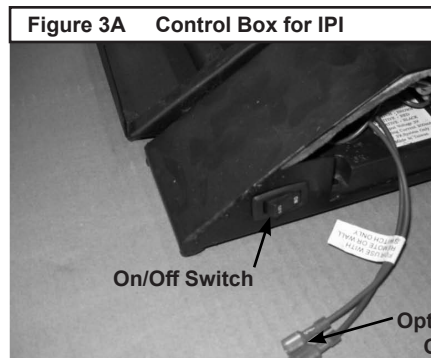

Figure 3A Control Box for IPI

On/Off Switch

Optional Remote Connection

- For propane (LP) installations skip to “J for Propane Gas Installation”.

I. For Natural Gas Installation (for all units)

- Pour sand into the burner pans to the point where the burner pipe is covered. See Figure 5. Level the sand from right to left to ensure an even flame pattern. At this point the pan should be half full. Be sure not to cover pilot assembly.

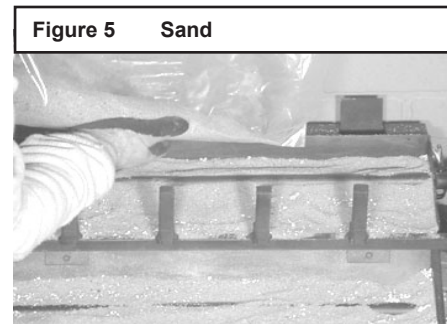

Figure 5 Sand

- Pour vermiculite over the sand in the pans until they are full. See Figure 6.

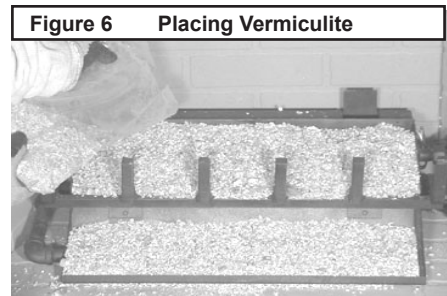

Figure 6 Placing Vermiculite

- Lightly place dime-size pieces of rock wool evenly on top of the sand and vermiculite completely covering the pan surfaces. See Figure 7.



Figure 7 Placing Rock Wool

Tightly pack dime sized pieces of rock wool around the vertical part of the carry over tube to aid lighting the bottom burner pan. See Figure 8a. Cover the rest of the exposed tube with additional rock wool pieces. See Figures 8b and 8c.

Note: For best results, do not pack down the rock wool except around the carry over tube. The placement of rock wool can have an effect on flame pattern and may need to be adjusted to achieve a desired appearance.

Figure 8a- Carry over tube



Figure 8b- Packing rock wool around the carry over tube







Figure 8c- Carry over tube covered by rock wool



Figure 9- Adjusting of Flame Pattern







- **Inspect the pilot burner to ensure it is clear of any rock wool.**
- Remove the Platinum Bright Embers™ from the package. For optimum performance peel each piece apart in layers and lightly place on top of the vermiculite and rock wool where the flame is blue. This will achieve the desired realism.
- The gas burns at the point of the least resistance. In case of an uneven flame pattern it may be necessary to adjust the materials in the pans (using an object such as a screwdriver) to achieve the desired effect. See Figure 9.
- Place desired amount of lava granules on the floor of the fireplace. **DO NOT ALLOW THE GRANULES TO COME IN CONTACT WITH THE FLAMES.** (Lava granules may contain moisture which, when heating, may cause it to pop out during installation and set-up.) Ensure the controls and switches are unobstructed after the granules are installed.
- Place logs. See Service Parts.
- Place accent logs around burner on floor of fireplace.

	WARNING	
	Fire Risk	
	Explosion Risk	
	Personal Injury Risk	
	Failure to position the parts in accordance with the diagrams provided with the log packages or failure to use only parts approved with this appliance may result in property damage or personal injury.	





Pour vermiculite into each burner pan to the point where each pan is completely full. Level the vermiculite from right to left to ensure an even flame pattern. See figure 6.

- Lightly place dime-size pieces of rock wool evenly on top of the sand and vermiculite completely covering the pan surfaces. See Figure 7.

J. For Propane Gas Installation (for all units).

	WARNING	
	Fire Risk	
	Explosion Risk	
	Personal Injury Risk	
	An explosion could occur if a connection is made directly to an unregulated propane (LP) tank.	

Lightly pack dime sized pieces of rock wool around the vertical part of the carry over tube to aid lighting the bottom burner pan. See Figure 8a. Cover the rest of the exposed tube with additional rock wool pieces. See Figures 8b and 8c.

	WARNING	
	Fire Risk	
	Explosion Risk	
	Personal Injury Risk	
	Pour vermiculite into each burner pan (LP) to the point where each pan is completely full. Failure to do so may cause the lighting to be delayed and this can be dangerous..	

- **Inspect the pilot burner to ensure it is clear of any rock wool.**
- Remove the Platinum Bright Embers™ from the package. For optimum performance peel each piece apart in layers and lightly place on top of the vermiculite and rock wool where the flame is blue. This will achieve the desired realism.
- The gas burns at the point of the least resistance. In case of an uneven flame pattern it may be necessary to adjust the materials in the pans (using an object such as a screwdriver) to achieve the desired effect. See Figure 9.
- Place desired amount of lava granules on the floor of the fireplace. **DO NOT ALLOW THE GRANULES TO COME IN CONTACT WITH THE FLAMES.** (Lava granules may contain moisture which, when heating, may cause it to pop out during installation and set-up.) Ensure the controls and switches are unobstructed after the granules are installed.
- Place logs. See Service Parts.
- Place accent logs around burner on floor of fireplace.

Note: For best results, do not pack down the rock wool except around the carry over tube. The placement of rock wool can have an effect on flame pattern and may need to be adjusted to achieve a desired appearance.

Note: Be sure to not cover the pilot assembly (located on the right side of the burner pan, installed in the vertical position) with vermiculite.

K. Inspect the Venting System

The fireplace venting system is designed and constructed to develop a positive flow adequate to remove flue gases to the outside atmosphere. See fireplace installation instructions.

Note: The state of Massachusetts requires that the chimney flue damper, when used with gas logs, be welded open or completely removed. In the Commonwealth of Massachusetts this appliance must be installed by a licensed plumber or gasfitter.

A spillage test must be made before the installed appliance is left with the consumer.

- Close all doors and windows in the home.
- Light the log set (see Lighting Instructions).
- After three minutes, test with a smoke match, smoke candle, stick incense or cigarette 1 in. below the top of the opening (lintel) moving across the full width. If spillage (smoke down into the room) occurs, it will most likely be near the top, outside corners.

Possible cures if spilling occurs:

- The damper needs to be opened further.
- The fireplace opening needs to be reduced by adding a drop panel across the top under the lintel.
- The air supply from outdoors needs to be increased. Open the outside air kit if the appliance is so equipped, or crack open a door or window.
- If necessary, seek expert advice. Do not operate this appliance.

L. Damper Stop Installation Instructions

Included in the burner assembly box is a damper stop clamp which attaches to the damper as shown (Figure 8). Install the clamp to the damper ensuring that the minimum requirements (Tables 1 and 2) are achieved. Use a 7/16 in. wrench to secure the clamp to the damper. If the damper clamp provided does not fit your application, other means of securing the proper opening must be provided by the installer.

CAUTION

- Logs can get very hot. Handle only when they are cool.

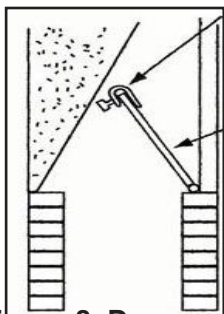

Figure 8 Damper Stop Clamp

Cleaning

- Periodic examination and cleaning of the venting system of the fireplace should be done before initial use and at least annually by a qualified agency.

CAUTION
Before cleaning the appliance, be sure it is turned completely off. The pilot should also be turned off. The unit must be completely cooled.

M. Cleaning and Maintenance Instructions

Always remember:

- Do not place any combustible material near the appliance.
- Do not place any paper, trash or other material on the log set or in the fireplace.
- Do not touch any part of the appliance when it is in operation.
- Do not operate this appliance without the fireplace screen closed.

Your appliance is designed to be virtually maintenance free, although periodic visual inspection and cleaning is required. Follow the instructions below for the correct procedures. An annual examination and cleaning the venting system by a qualified person is also recommended.

Do not allow soot to build up on the logs

Your logs require little care. Keep the burner assembly, logs and burner area surrounding the logs clean by brushing with a dry paint brush at least twice a year.

- Always turn off the gas to the pilot before cleaning. For relighting, refer to Section N. Lighting Instructions.
- Always keep the appliance clean and free from combustible materials, gasoline and other flammable vapors and liquids.
- Never obstruct the flow of combustion and ventilation air. Keep the front of the appliance clear of all obstacles and materials.
- Leave clearance of at least 36 in. from the front of the fireplace.
- The air shutter should not be blocked.

CAUTION
After burning, the logs become fragile. Take care in handling.

N. Lighting Instructions • IPI Pilot Valve (IPI)

FOR YOUR SAFETY READY BEFORE LIGHTING

WARNING: If you do not follow these instructions exactly, a fire or explosion may result causing property damage, personal injury or loss of life.

- A. This appliance is equipped with an intermittent Pilot ignition (IPI) device which automatically lights the burner. DO NOT try to light the burner by hand.
- B. BEFORE LIGHTING, smell all around the appliance area for gas. Be sure to smell next to the floor because some gas is heavier than air and will settle on the floor.

WHAT TO DO IF YOU SMELL GAS

Do not try to light any appliance.

Do not touch any electrical switch: do not use any phone in your building.

Immediately call your gas supplier from a neighbor's phone. Follow gas supplier's instructions.

If you cannot reach your gas supplier, call the fire department.

- C. Do not use this appliance if any part has been under water. Immediately call a qualified service technician to inspect the appliance and replace any part of the control system and any gas control which has been under water.

WARNING

DO NOT CONNECT 110 VAC TO THE CONTROL VALVE.

- Improper installation, adjustment, alteration, service or maintenance can cause injury or property damage.
- This appliance needs fresh air for safe operation and must be installed so there are provisions for adequate combustion and ventilation.
- If not installed, operated, and maintained in accordance with the manufacture's instructions, this product could expose you to substances in fuel or fuel combustion which are known to the State of California to cancer, birth defects or other reproductive harm.
- Keep burner and control compartment clean.

CAUTION

Hot while in operation. Do not touch. Keep children, clothing, furniture, gasoline and other liquids having flammable vapors away.

LIGHTING INSTRUCTIONS IPI

1. Turn off all electric power to the appliance.
2. This appliance is equipped with an ignition device which automatically lights the burner. DO NOT try to light the burner by hand.
3. Wait (5) minutes to clear out any gas. Then smell for gas, including near the floor. If you smell gas, STOP! Follow "B" in the Safety Information above. If you do not smell gas, go to the next step.
4. Turn on all electric power to the appliance.
5. To light the burner, flip the ON/OFF switch to the "ON" position (the ON/OFF switch may include a wall switch, if so equipped).
6. If the appliance will not operate, follow the instructions "To Turn Off Gas to Appliance" and call your service technician or gas supplier.

TO TURN OFF GAS TO APPLIANCE

1. Turn off all electric power to the appliance if service is to be performed.
2. Flip the ON/OFF switch to the "OFF" position.

Gas Valve

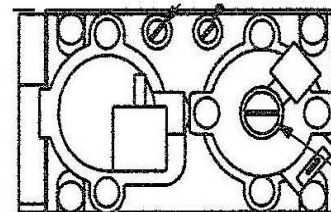

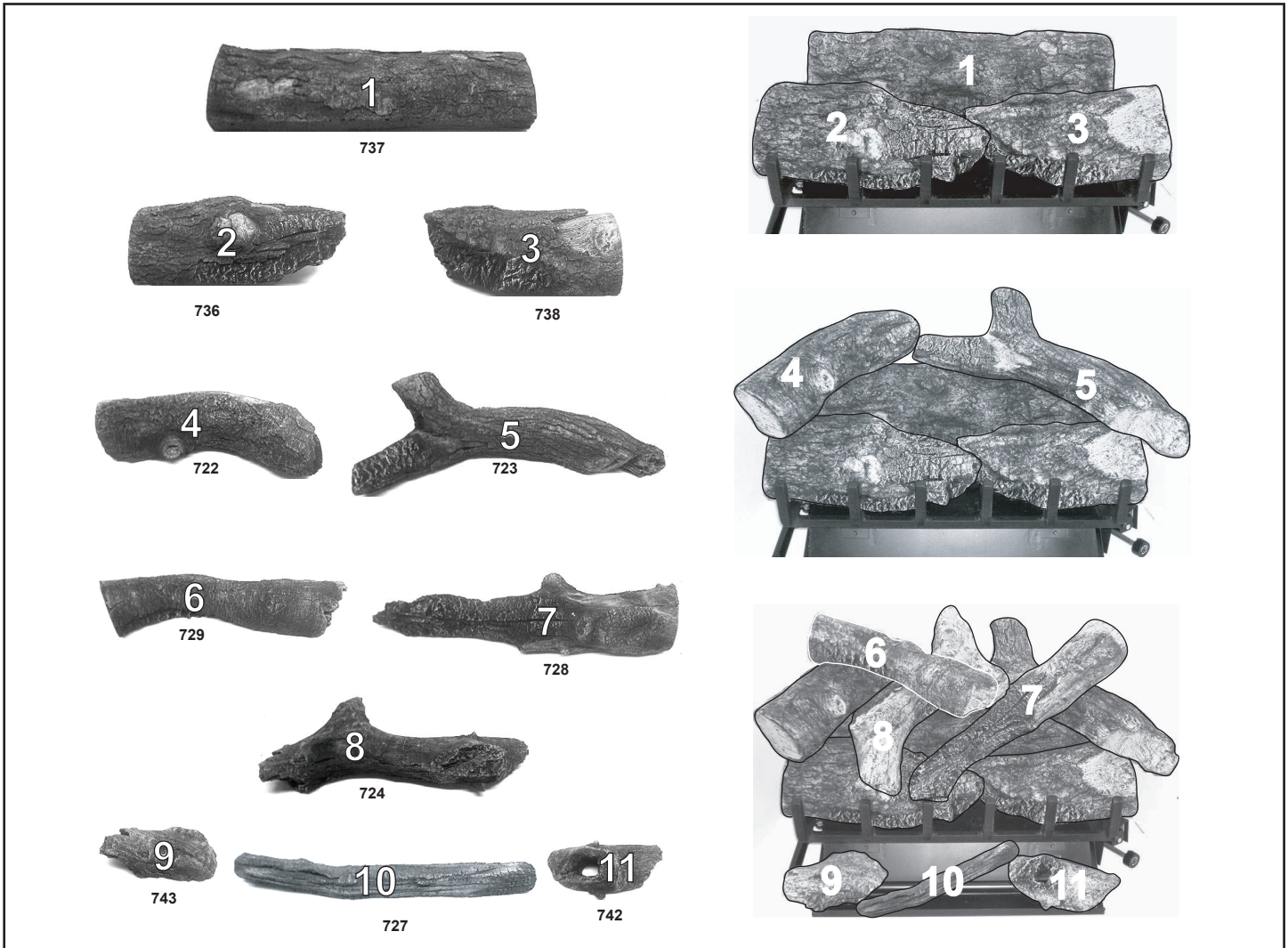

IMPORTANT: THIS IS DATED INFORMATION. Parts must be ordered from a dealer or distributor. **Hearth and Home Technologies does not sell directly to consumers.** Provide model number and serial number when requesting service parts from your dealer or distributor.



**Stocked
at Depot**

ITEM	DESCRIPTION	COMMENTS	PART NUMBER
	Log Set Assembly		GO24
1	Log # 1		SRV737
2	Log # 2		SRV736
3	Log # 3		SRV738
4	Log # 4		SRV722
5	Log # 5		SRV723
6	Log # 6		SRV729
7	Log # 7		SRV728
8	Log # 8		SRV724
9	Log # 9		SRV743
10	Log # 10		SRV727
11	Log # 11		SRV742

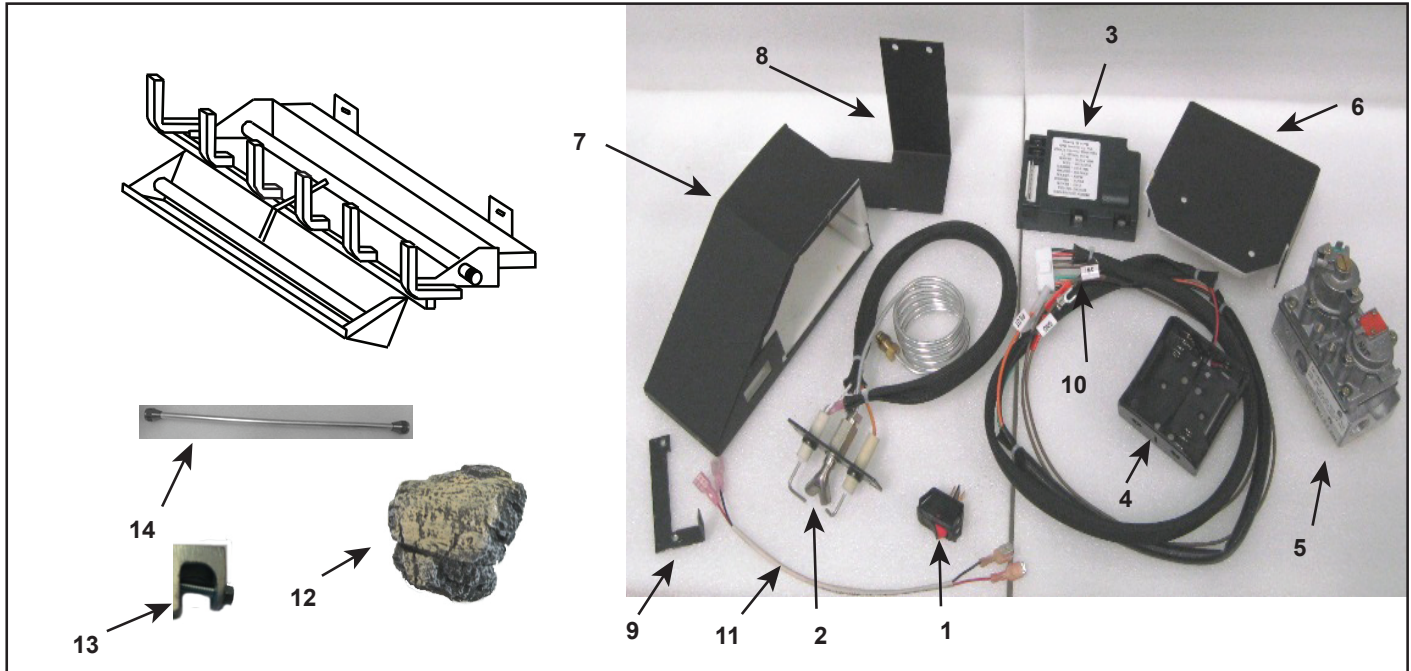

IMPORTANT: THIS IS DATED INFORMATION. Parts must be ordered from a dealer or distributor. **Hearth and Home Technologies does not sell directly to consumers.** Provide model number and serial number when requesting service parts from your dealer or distributor.



Stocked at Depot

ITEM	DESCRIPTION	COMMENTS	PART NUMBER	
1	Switch		01-1070	
2	Pilot - NG		07-1024	
	Pilot - LP		07-1023	
3	Control Module		593-595	Y
4	Battery Holder		SRV593-594	Y
5	Valve - NG		593-500	Y
	Valve - LP		SRV593-501	Y
6	Valve Bracket		MT-350-VC	
7	Control Box		MT-350-CBA	
8	Control Box Mount		MT-350-CBM	
9	Pilot Bracket		MT-350-PB3	
10	Wire Harness		SRV593-590	Y
11	Wiring Harness, Switch		16-1615	
12	Battery Cover Log		H-0586A	
13	Damper Stop Assembly		SRV500-SC	
14	Connector		FT-1-24	
	Lava Rock	Qty 2 req	SRVACC10	
	Mineral Wool		SRVACC12	
	Platinum Bright Embers		PBE-5	
	Sand	NG Only	SRVACC15	
	Vermiculite		SRVACC11	
	Installation Manual		4004-323	

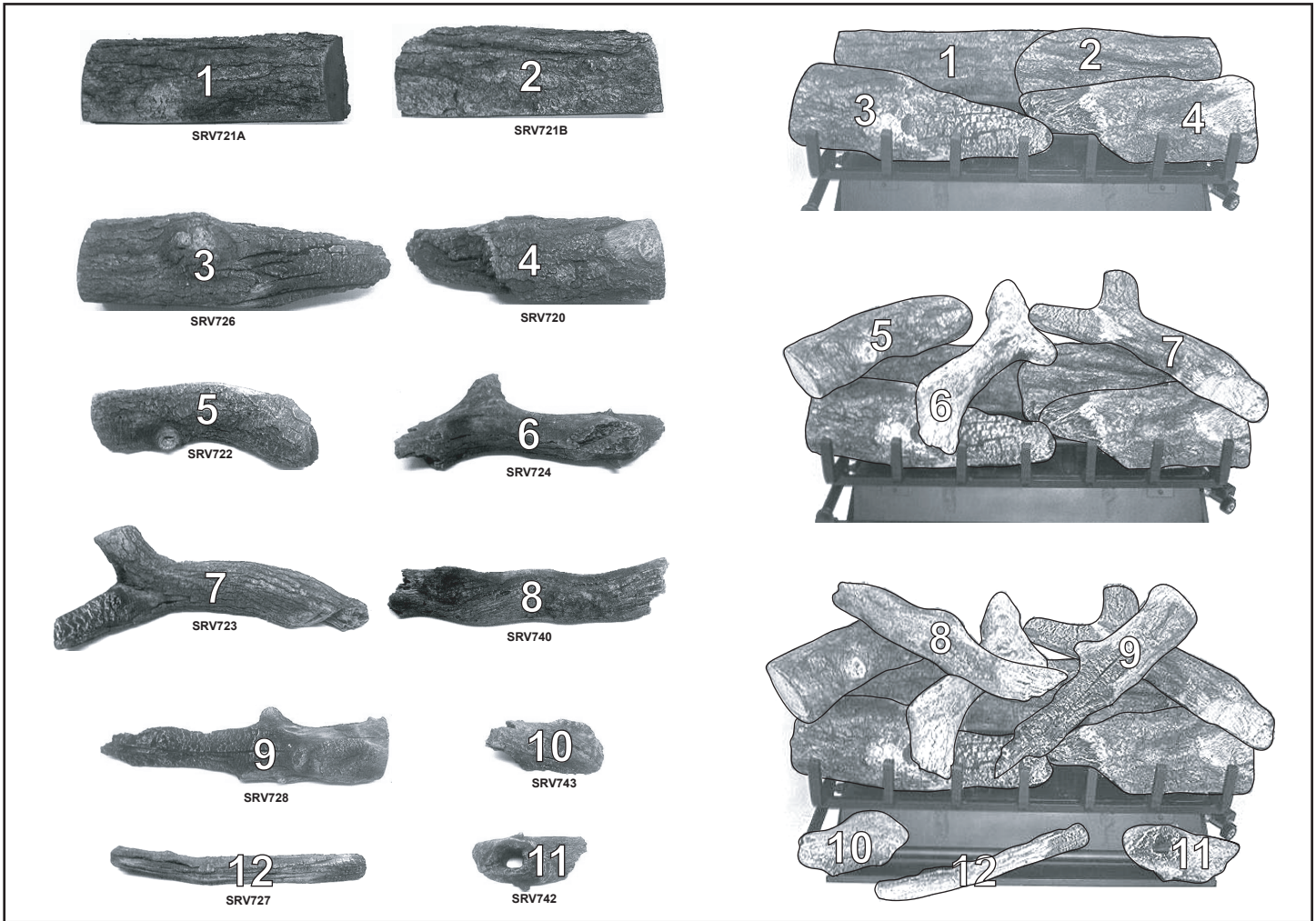

IMPORTANT: THIS IS DATED INFORMATION. Parts must be ordered from a dealer or distributor. **Hearth and Home Technologies does not sell directly to consumers.** Provide model number and serial number when requesting service parts from your dealer or distributor.



Stocked at Depot

ITEM	DESCRIPTION	COMMENTS	PART NUMBER	
	Log Set Assembly		GO30	
1	Log # 1		SRV721A	
2	Log # 2		SRV721B	
3	Log # 3		SRV726	
4	Log # 4		SRV720	
5	Log # 5		SRV722	
6	Log # 6		SRV724	
7	Log # 7		SRV723	
8	Log # 8		SRV740	
9	Log # 9		SRV728	
10	Log # 10		SRV743	
11	Log # 11		SRV742	
12	Log # 12		SRV727	

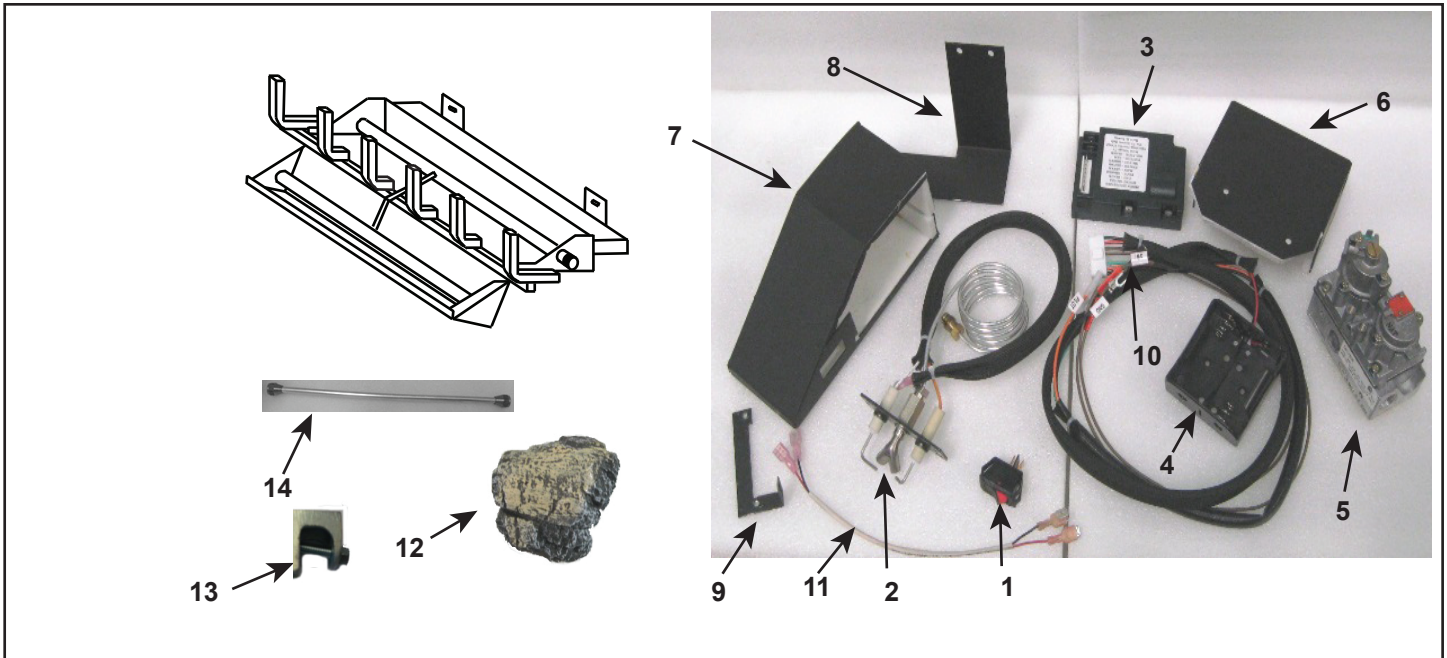

IMPORTANT: THIS IS DATED INFORMATION. Parts must be ordered from a dealer or distributor. **Hearth and Home Technologies does not sell directly to consumers.** Provide model number and serial number when requesting service parts from your dealer or distributor.



Stocked at Depot

ITEM	DESCRIPTION	COMMENTS	PART NUMBER	
1	Switch		01-1070	
2	Pilot - NG		07-1024	
	Pilot - LP		07-1023	
3	Control Module		593-595	
4	Battery Holder		SRV593-594	
5	Valve - NG		593-500	
	Valve - LP		SRV593-501	
6	Valve Bracket		MT-350-VC	
7	Control Box		MT-350-BBA	
8	Control Box Mount		MT-350-CBMS	
9	Pilot Bracket		MT-350-PB	
10	Wire Harness		SRV593-590	
11	Wiring Harness, Switch		16-1615	
12	Battery Cover Log		H-0586A	
13	Damper Stop Assembly		SRV500-SC	
14	Connector		FT-1-24	
	Lava Rock	Qty 3 req	SRVACC10	
	Mineral Wool	Qty 2 req	SRVACC12	
	Platinum Bright Embers	Qty 2 req	PBE-5	
	Sand	Qty 1 req, NG Only	SRVACC15	
	Vermiculite	Qty 1 req, NG	SRVACC11	
		Qty 2 req, LP		
	Installation Manual		4004-323	

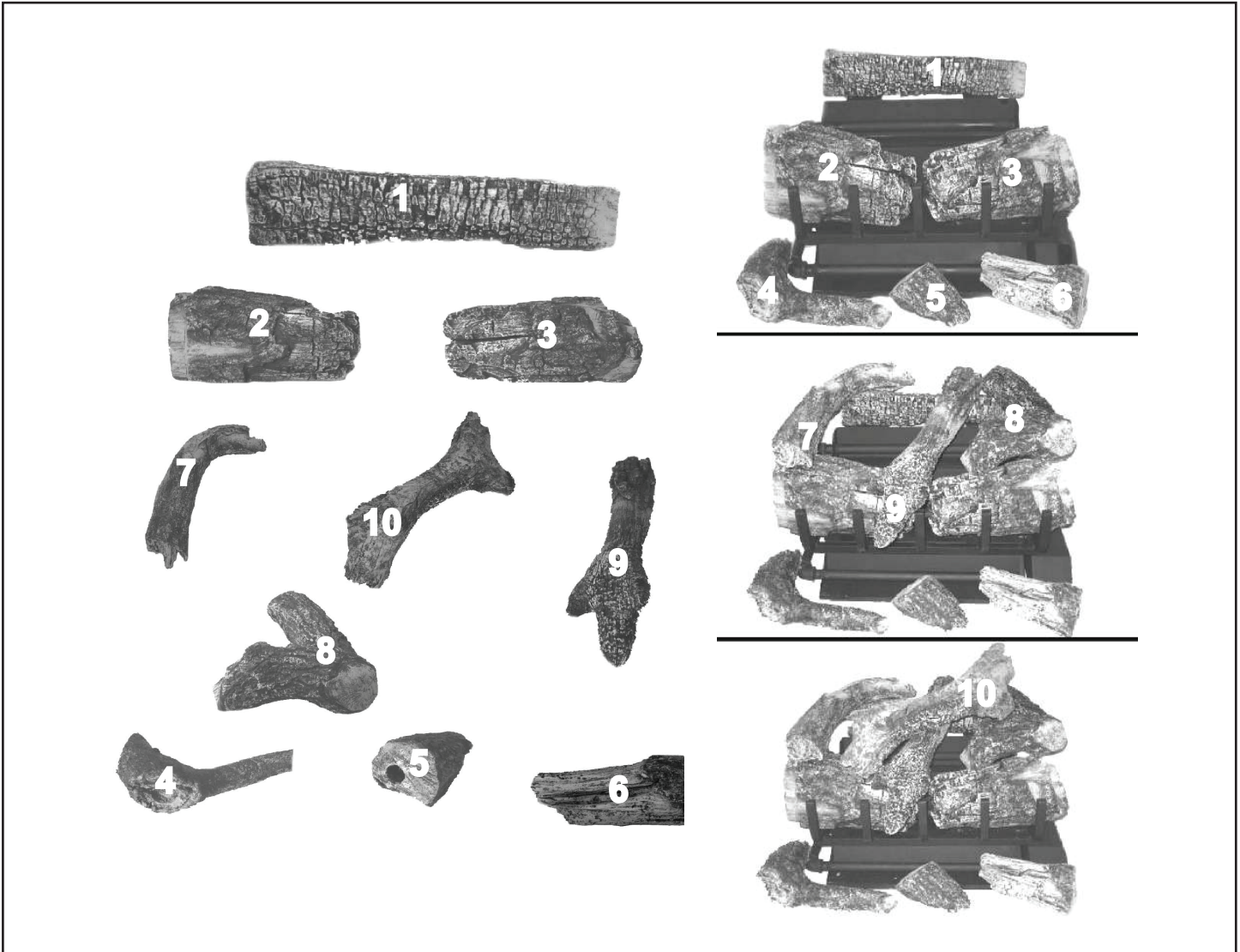

IMPORTANT: THIS IS DATED INFORMATION. Parts must be ordered from a dealer or distributor. **Hearth and Home Technologies does not sell directly to consumers.** Provide model number and serial number when requesting service parts from your dealer or distributor.



Stocked at Depot

ITEM	DESCRIPTION	COMMENTS	PART NUMBER	
	Log Set Assembly		GO318	
1	Log # 1		SRV637	
2	Log # 2		SRV628	
3	Log # 3		SRV629	
4	Log # 4		SRV707	
5	Log # 5		SRV702	
6	Log # 6		SRV706	
7	Log # 7		SRV816	
8	Log # 8		SRV75	
9	Log # 9		SRV454	
10	Log # 10		SRV724	

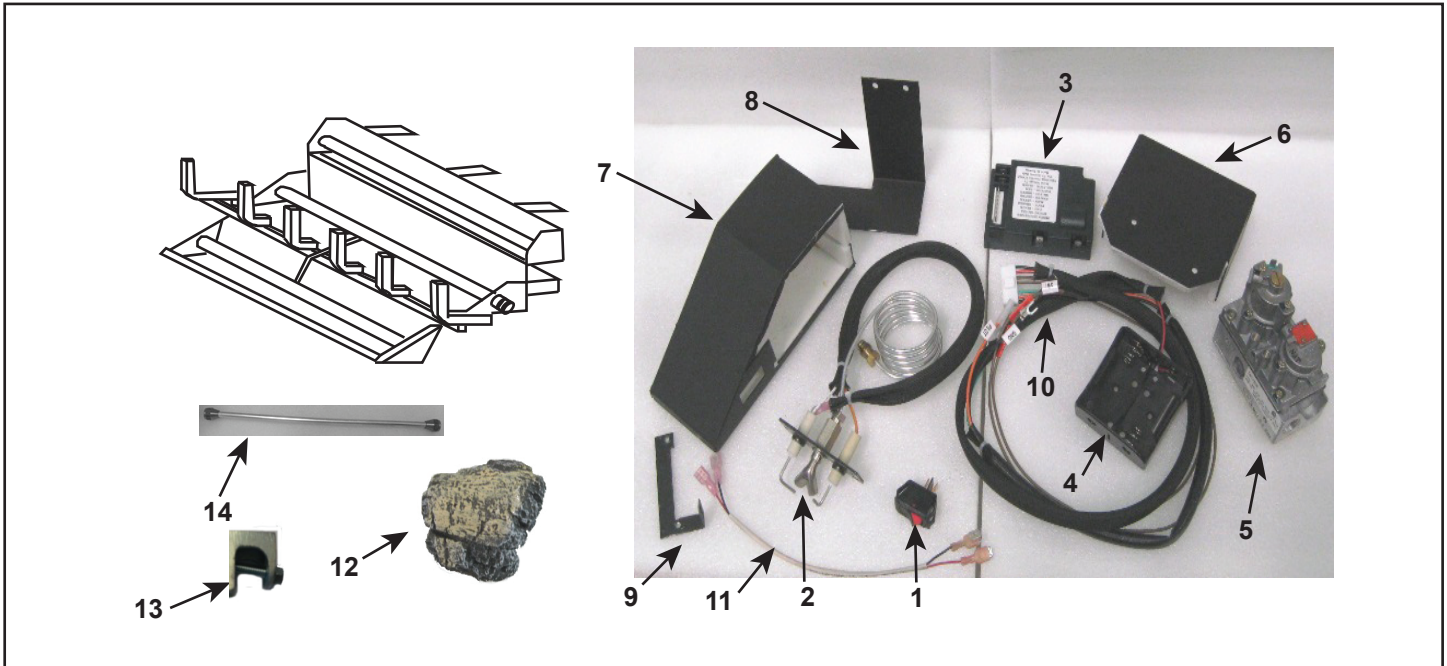

IMPORTANT: THIS IS DATED INFORMATION. Parts must be ordered from a dealer or distributor. **Hearth and Home Technologies does not sell directly to consumers.** Provide model number and serial number when requesting service parts from your dealer or distributor.



**Stocked
at Depot**

ITEM	DESCRIPTION	COMMENTS	PART NUMBER	
1	Switch		01-1070	
2	Pilot - NG		07-1024	
	Pilot - LP		07-1023	
3	Control Module		593-595	Y
4	Battery Holder		SRV593-594	Y
5	Valve - NG		593-500	Y
	Valve - LP		SRV593-501	Y
6	Valve Bracket		MT-350-VC	
7	Control Box		MT-350-CBA	
8	Control Box Mount		MT-350-CBM	
9	Pilot Bracket		MT-350-PB3	
10	Wire Harness		SRV593-590	Y
11	Wiring Harness, Switch		16-1615	
12	Battery Cover Log		H-0586A	
13	Damper Stop Assembly		SRV500-SC	
14	Connector		FT-1-18	
	Lava Rock	Qty 2 req	SRVACC10	
	Mineral Wool		SRVACC12	
	Platinum Bright Embers		PBE-5	
	Sand	NG Only	SRVACC15	
	Vermiculite		SRVACC11	
	Installation Manual		4004-323	



IMPORTANT: THIS IS DATED INFORMATION. Parts must be ordered from a dealer or distributor. **Hearth and Home Technologies does not sell directly to consumers.** Provide model number and serial number when requesting service parts from your dealer or distributor.



Stocked at Depot

ITEM	DESCRIPTION	COMMENTS	PART NUMBER
	Log Set Assembly		GO324
1	Log # 1		SRV737
2	Log # 2		SRV708
3	Log # 3		SRV709
4	Log # 4		SRV816
5	Log # 5		SRV728
6	Log # 6		SRV716
7	Log # 7		SRV808
8	Log # 8		SRV724
9	Log # 9		SRV707
10	Log # 10		SRV706
11	Log # 11		SRV702

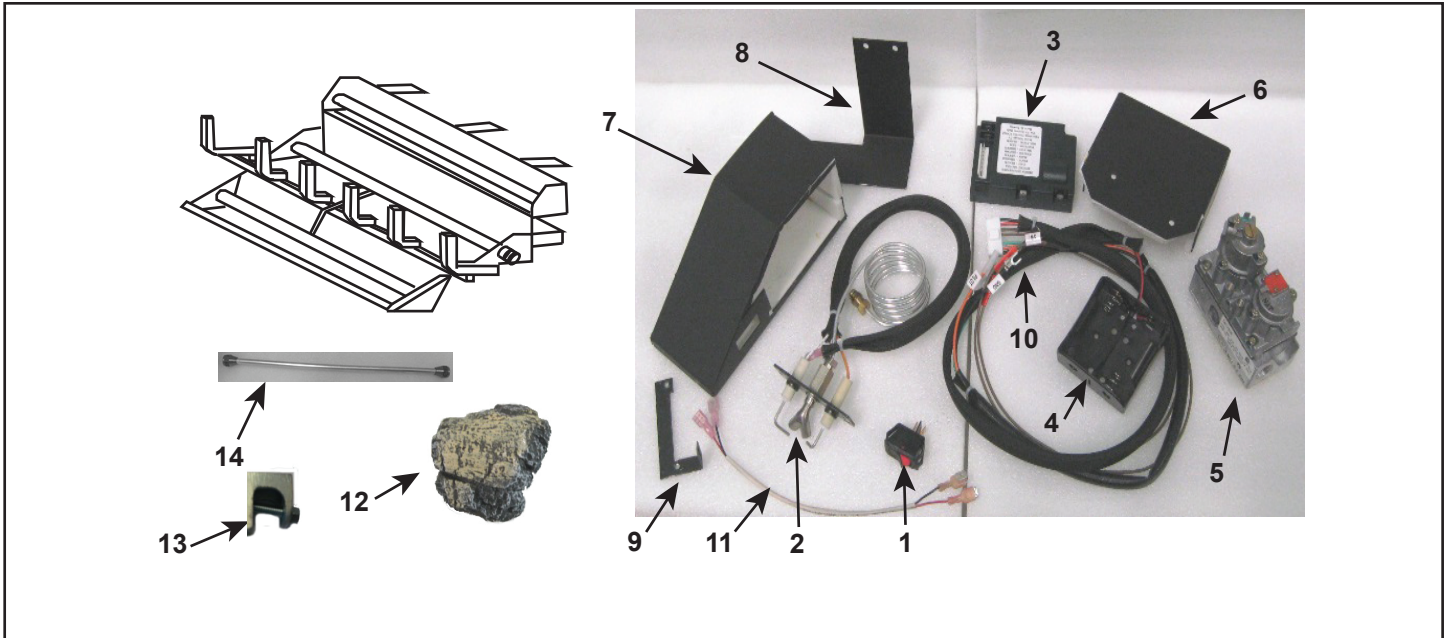

IMPORTANT: THIS IS DATED INFORMATION. Parts must be ordered from a dealer or distributor. **Hearth and Home Technologies does not sell directly to consumers.** Provide model number and serial number when requesting service parts from your dealer or distributor.



Stocked at Depot

ITEM	DESCRIPTION	COMMENTS	PART NUMBER	
1	Switch		01-1070	
2	Pilot Assembly NG		07-1024	
	Pilot Assembly LP		07-1023	
3	Control Module		593-595	Y
4	Battery Holder		SRV593-594	Y
5	Valve - NG		593-500	Y
	Valve - LP		SRV593-501	Y
6	Valve Bracket		MT-350-VC	
7	Control Box		MT-350-CBA	
8	Control Box Mount		MT-350-CBM	
9	Pilot Bracket		MT-350-PB3	
10	Wire Harness		SRV593-590	Y
11	Wiring Harness, Switch		16-1615	
12	Battery Cover Log		H-0586A	
13	Damper Stop Assembly		SRV500-SC	
14	Connector		FT-1-24	
	Lava Rock	Qty 2 req	SRVACC10	
	Mineral Wool	Qty 2 req	SRVACC12	
	Platinum Bright Embers	Qty 2 req	PBE-5	
	Sand	NG Only	SRVACC15	
	Vermiculite	Qty 1 req, NG	SRVACC11	
		Qty 2 req, LP		
	Installation Manual		4004-323	



IMPORTANT: THIS IS DATED INFORMATION. Parts must be ordered from a dealer or distributor. **Hearth and Home Technologies does not sell directly to consumers.** Provide model number and serial number when requesting service parts from your dealer or distributor.



Stocked at Depot

ITEM	DESCRIPTION	COMMENTS	PART NUMBER
	Log Set Assembly		GO330
1	Log # 1		SRV721A
2	Log # 2		SRV721B
3	Log # 3		SRV700
4	Log # 4		SRV701
5	Log # 5		SRV816
6	Log # 6		SRV728
7	Log # 7		SRV703
8	Log # 8		SRV808
9	Log # 9		SRV724
10	Log # 10		SRV707
11	Log # 11		SRV706
12	Log # 12		SRV702

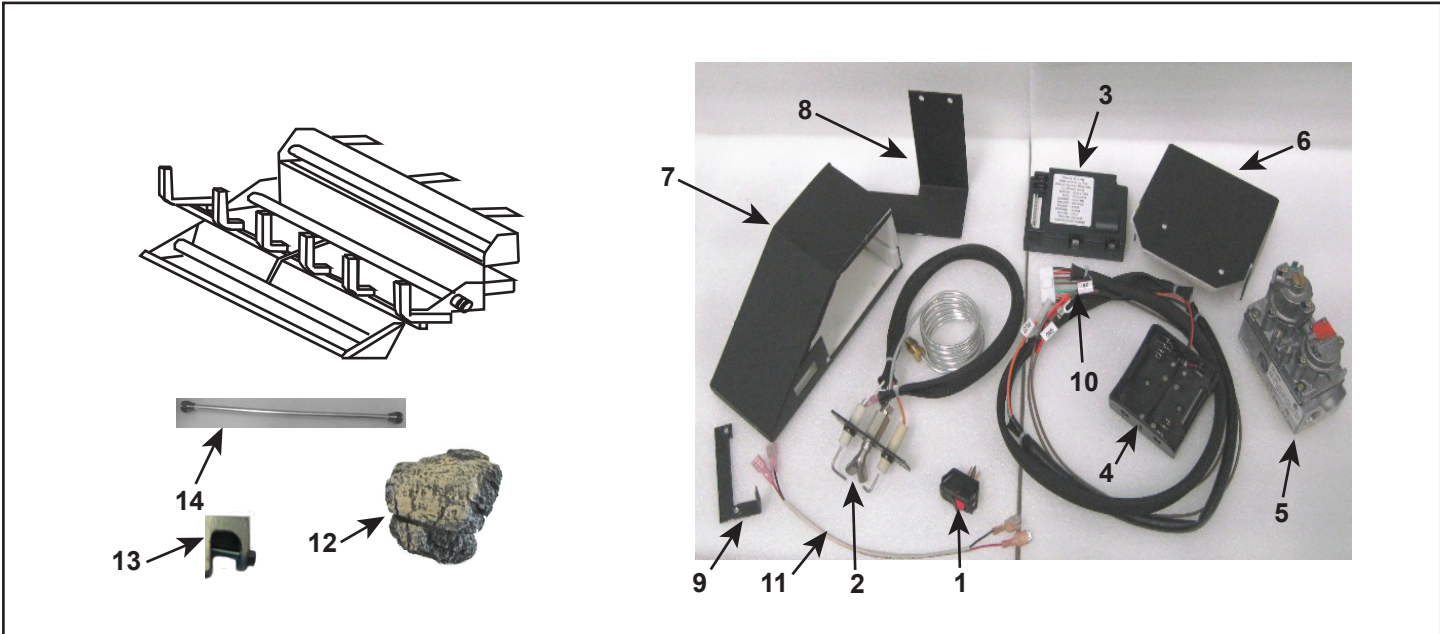

IMPORTANT: THIS IS DATED INFORMATION. Parts must be ordered from a dealer or distributor. **Hearth and Home Technologies does not sell directly to consumers.** Provide model number and serial number when requesting service parts from your dealer or distributor.



Stocked at Depot

ITEM	DESCRIPTION	COMMENTS	PART NUMBER	
1	Switch		01-1070	
2	Pilot - NG		07-1024	
	Pilot - LP		07-1023	
3	Control Module		593-595	Y
4	Battery Holder		SRV593-594	Y
5	Valve - NG		593-500	Y
	Valve - LP		SRV593-501	Y
6	Valve Bracket		MT-350-VC	
7	Control Box		MT-350-CBA	
8	Control Box Mount		MT-350-CBM	
9	Pilot Bracket		MT-350-PB3	
10	Wire Harness		SRV593-590	Y
11	Wiring Harness, Switch		16-1615	
12	Battery Cover Log		H-0586A	
13	Damper Stop Assembly		SRV500-SC	
14	Connector		FT-1-24	
	Lava Rock	Qty 3 req	SRVACC10	
	Mineral Wool	Qty 2 req	SRVACC12	
	Platinum Bright Embers	Qty 3 req	PBE-5	
	Sand	Qty 2 req, NG Only	SRVACC15	
	Vermiculite	Qty 1 req, NG	SRVACC11	
		Qty 2 req, LP		
	Installation Manual		4004-323	

O. Frequently Asked Questions

Can I close the glass doors on my fireplace when using my hearth kit?

No. The gas hearth kits are designed for use in fireplaces with all fireplace doors fully opened. Operating your hearth kit with the doors closed will cause overheating, premature failure of valve systems, and will void the warranty of your log set.

What sort of maintenance do gas hearth kits require?

Vented gas hearth kits do not require regular maintenance. However, it is a good idea to have valves, pilots and gas connections on your set periodically inspected by a hearth professional. Although it is not required maintenance, annually refurbishing the ember material and periodic cleaning of the logs will help maintain your set's beauty and realism.

Does the ember material burn-up, and do I need to replace it periodically?

The ember material is a fireproof, organic mineral material called rock wool, and does not burn or require periodic replacement; however, annual refurbishment of the embers will help maintain the beauty and realism of your log set.

Can I burn real wood along with my gas logs?

No. The intense heat of a wood fire will damage your logs, burners, grates and valves, and will void your warranty.

Will gas logs help my chimney that drafts poorly?

No. Improper or poor draft will not be helped by a gas appliance. Please have your chimney inspected by a hearth professional or chimney sweep in order to determine how to correct the problem.

Can I close my fireplace damper to get more heat from my vented gas hearth kit?

No. Vented gas hearth kits are designed to be operated with the damper in the fully opened position. This gas log set produces carbon monoxide gas. The damper must be removed or clamped fully open using the "C" clamp provided with the set.

My gas hearth kit makes a whistling noise when I burn them. What causes this?

This behavior is normally caused by using a corrugated flex connector to hook up the gas log set. We recommend the installer use the supplied aluminum connector rather than the corrugated flexible type.

Can I move or change the position of the logs on my gas hearth kit?

Certified log sets should not be altered - log placement must be exactly as indicated in the set's installation instructions.

Can I install my gas hearth kit myself?

No. We recommend installation be performed by an NFI certified hearth professional, HVAC professional, gas fitter, or plumber experienced in gas log installation. Most localities require installation of any gas appliance to be performed by a professional. Please check with your local inspection agency/department.

What are the gas logs made of?

The gas logs are made of a mixture of pre-fired, expanded clay and a special high-temperature cement, with a wire mesh reinforcement. This combination creates a strong, ceramic material capable of withstanding extreme temperatures, yet also allows molding of the intricate detail found in these gas log sets.

I have a vented hearth kit, and the logs have black soot on them. Is this normal?

Soot build-up on vented hearth kits is a normal part of the combustion process. Natural gas hearth kits generally produce less soot than liquid propane log sets. We recommend any soot build up be removed periodically using a product designed for gas log soot removal.

Can I add a remote control to my gas hearth kit after it has been installed?

You can easily add a remote to the gas hearth kit if it is already equipped with an IPI ignition system.

Is the gas log set approved by a testing agency?

Yes. The GO series has been design certified by PFS under the **ANSI Z21.60-2017 Decorative Appliances for Installation in Solid Fuel Burning Fireplaces**. The installation and the provisions for combustion and ventilation air must conform to the **National Fuel Gas Code, ANSI Z223.1/NFPA 54**. Check with your local inspections department for further information.

Hearth & Home Technologies
LIMITED LIFETIME WARRANTY

Hearth & Home Technologies, on behalf of its hearth brands (“HHT”), extends the following warranty for HHT gas, wood, pellet and electric hearth appliances that are purchased from an HHT authorized dealer.

WARRANTY COVERAGE:

HHT warrants to the original owner of the HHT appliance at the site of installation, and to any transferee taking ownership of the appliance at the site of installation within two years following the date of original purchase, that the HHT appliance will be free from defects in materials and workmanship at the time of manufacture. After installation, if covered components manufactured by HHT are found to be defective in materials or workmanship during the applicable warranty period, HHT will, at its option, repair or replace the covered components. HHT, at its own discretion, may fully discharge all of its obligations under such warranties by replacing the product itself or refunding the verified purchase price of the product itself. The maximum amount recoverable under this warranty is limited to the purchase price of the product. This warranty is subject to conditions, exclusions and limitations as described below.

WARRANTY PERIOD:

Warranty coverage for consumers begins at the date of installation. In the case of new home construction, warranty coverage begins on the date of first occupancy of the dwelling or six months after the sale of the product by an independent, authorized HHT dealer/distributor, whichever occurs earlier. However, the warranty shall commence no later than 24 months following the date of product shipment from HHT, regardless of the installation or occupancy date. The warranty period for parts and labor for covered components is produced in the following table.

The term “Limited Lifetime” in the table below is defined as: 20 years from the beginning date of warranty coverage for gas appliances, and 10 years from the beginning date of warranty coverage for wood and pellet appliances. These time periods reflect the minimum expected useful lives of the designated components under normal operating conditions.

Warranty Period		HHT Manufactured Appliances and Venting					
Parts	Labor	Gas	Pellet	Wood	Electric	Venting	Components Covered
1 Year		X	X	X	X	X	All parts including handles, external enameled components and other material except as covered by Conditions, Exclusions, and Limitations listed
2 years			X	X			Igniters, Auger Motors, Electronic Components, and Glass
		X					Electrical components limited to modules, remotes/wall switches, valves, pilots, blowers, junction boxes, wire harnesses, transformers and lights (excluding light bulbs)
		X		X			Molded Refractory Panels, Glass Liners
3 years			X				Firepots, burnpots, mechanical feeders/auger assemblies
5 years	1 year	X					Vent Free Burners, Vent Free Logs
			X	X			Castings, Medallions and Baffles
6 years	3 years			X			Catalyst - Limitations Listed
7 years	3 years		X	X			Manifold tubes, HHT Chimney and Terminations
10 years	1 year	X					Burners, logs and refractory
Limited Lifetime	3 years	X	X	X			Firebox and heat exchanger, FlexBurn® System (engine, inner cover, access cover and fireback)
1 Year	None	X	X	X	X	X	All replacement parts beyond warranty period

See conditions, exclusions and limitations on the next page

WARRANTY CONDITIONS:

- This warranty only covers HHT appliances that are purchased through an HHT authorized dealer or distributor. A list of HHT authorized dealers is available on the HHT branded websites.
- This warranty is only valid while the HHT appliance remains at the site of original installation.
- This warranty is only valid in the country in which the HHT authorized dealer or distributor that sold the appliance resides.
- Contact your installing dealer for warranty service. If the installing dealer or distributor is unable to provide necessary parts, contact the nearest HHT authorized dealer or supplier. Additional service fees may apply if you are seeking warranty service from a dealer other than the dealer from whom you originally purchased the product.
- Check with your dealer in advance for any costs to you when arranging a warranty call. Travel and shipping charges for parts are not covered by this warranty.
- Limited Catalyst Warranty
 - o For wood burning products containing a catalyst, the catalyst will be warranted for a six-year period to the original purchaser at the site of original installation. The purchaser must provide the name, address, and telephone number of the location where the product is installed, proof of original purchase date, date of failure, and any relevant information regarding the failure of the catalyst.

WARRANTY EXCLUSIONS:

This warranty does not cover the following:

- Changes in surface finishes as a result of normal use. As a heating appliance, some changes in color of interior and exterior surface finishes may occur. This is not a flaw and is not covered under warranty.
- Damage to printed, plated, or enameled surfaces caused by fingerprints, accidents, misuse, scratches, melted items, or other external sources and residues left on the plated surfaces from the use of abrasive cleaners or polishes.
- Repair or replacement of parts that are subject to normal wear and tear during the warranty period are not covered. These parts include: paint, wood and pellet gaskets, firebricks, grates, flame guides, batteries and the discoloration of glass.
- Expansion, contraction, or movement of certain parts causing noise. These conditions are normal and complaints related to this noise are not covered by this warranty.
- Damages resulting from: (1) failure to install, operate, or maintain the appliance in accordance with the installation instructions, operating instructions, and listing agent identification label furnished with the appliance; (2) failure to install the appliance in accordance with local building codes; (3) shipping or improper handling; (4) improper operation, abuse, misuse, continued operation with damaged, corroded or failed components, accident, or improperly/incorrectly performed repairs (5) environmental conditions, inadequate ventilation, negative pressure, or drafting caused by tightly sealed constructions, insufficient make-up air supply, or handling devices such as exhaust fans or forced air furnaces or other such causes; (6) use of fuels other than those specified in the operation instructions; (7) installation or use of components not supplied with the appliance or any other components not expressly authorized and approved by HHT; (8) modification of the appliance not expressly authorized and approved by HHT in writing; and/or (9) interruptions or fluctuations of electrical power supply to the appliance.
- Non-HHT venting components, hearth connections or other accessories used in conjunction with the appliance.
- Any part of a pre-existing fireplace system in which an insert or a decorative gas appliance is installed.
- HHT's obligation under this warranty does not extend to the appliance's capability to heat the desired space. Information is provided to assist the consumer and the dealer in selecting the proper appliance for the application. Consideration must be given to the appliance location and configuration, environmental conditions, insulation and air tightness of the structure.

This warranty is void if:

- The appliance has been over-fired, operated in atmospheres contaminated by chlorine, fluorine, or other damaging chemicals. Over-firing can be identified by, but not limited to, warped plates or tubes, deformation/warping of interior cast iron structure or components, rust colored cast iron, bubbling, cracking and discoloration of steel or enamel finishes.
- The appliance is subjected to prolonged periods of dampness or condensation.
- There is any damage to the appliance or other components due to water or weather damage which is the result of, but not limited to, improper chimney or venting installation.

LIMITATIONS OF LIABILITY

- The owner's exclusive remedy and HHT's sole obligation under this warranty, under any other warranty, express or implied, or in contract, tort or otherwise, shall be limited to replacement, repair, or refund, as specified above. In no event will HHT be liable for any incidental or consequential damages caused by defects in the appliance. Some states do not allow exclusions or limitation of incidental or consequential damages, so these limitations may not apply to you. This warranty gives you specific rights; you may also have other rights, which vary from state to state. EXCEPT TO THE EXTENT PROVIDED BY LAW, HHT MAKES NO EXPRESS WARRANTIES OTHER THAN THE WARRANTY SPECIFIED HEREIN. THE DURATION OF ANY IMPLIED WARRANTY IS LIMITED TO DURATION OF THE EXPRESSED WARRANTY SPECIFIED ABOVE.



Contact Information

Please contact your Hearth & Home Technologies dealer with any questions or concerns.

For the number of your nearest Hearth & Home Technologies dealer, please call 1-800-927-6841 or 1-888-427-3973.

- NOTES -

CAUTION



DO NOT DISCARD THIS MANUAL

- Important operating and maintenance instructions included.
- Read, understand and follow these instructions for safe installation and operation.
- Leave this manual with party responsible for use and operation.

